



## City of Keene Planning Board

### AGENDA

**Monday, February 26, 2024                      6:30 PM                      City Hall, 2<sup>nd</sup> Floor Council Chambers**

- I. **Call to Order** – Roll Call
- II. **Minutes of Previous Meeting** – January 22, 2024
- III. **Final Vote on Conditional Approvals**
- IV. **Extension Request**
  1. **S-08-23 – Subdivision – Markem, 150 Congress St** – Applicant and owner Markem Corporation, requests a first extension to the deadline to achieve active and substantial development for the subdivision application, S-08-23, for the subdivision of the parcel at 150 Congress St (TMP #598-002-000) into two lots and the removal of pavement and portions of an existing tunnel structure. The parcel is 31 ac and is located in the Industrial Park District.
- V. **Continued Public Hearing**
  1. **PB-2024-01 – Surface Water Protection Conditional Use Permit – 186 Gunn Rd** - Applicants and owners Ashley & Peter Greene request a reduction in the Surface Water Protection buffer from 75' to 30' to allow for the future subdivision and development of the parcel at 186 Gunn Rd (TMP #205-013-000). The parcel is 11 ac and is located in the Rural District.
- VI. **Public Hearings**
  1. **SPR-01-13, Modification #3 – Site Plan – Cheshire County Shooting Sports Education Foundation, 19 Ferry Brook Rd** - Applicant SVE Associates, on behalf of owner the Cheshire County Shooting Sports Education Foundation, proposes several site modifications, including the relocation of the previously approved stormwater management system, on the property at 19 Ferry Brook Rd (TMP #214-021-000). The parcel is 55 ac and is located in the Rural District.
  2. **SPR-04-21, Modification #3 – Site Plan – Hundred Nights, 122 Water St** - Applicant BCM Environmental & Land Law PLLC, on behalf of owners the Hundred Nights Foundation Inc, the Railroad Street Condominium Association, and the City of Keene, proposes to install

security lighting around the perimeter of the Hundred Nights site at 122 Water St (TMP #585-027-000). Waivers are requested from Section 20.7.3.C & Section 20.7.3.F.1.c of the LDC regarding light trespass onto the adjacent properties at 0 Water St & 0 Cypress St (TMP#s 574-041-000 & 585-026-000) and lighting hours of operation. The Hundred Nights site is 0.62 ac and is located in the Downtown Growth District.

VII. **Capital Improvement Program FY 2025-2031** – Presentation by Merri Howe, City of Keene Finance Director and Jesse Rounds, Community Development Director.

VIII. **Fee Schedule Updates**

IX. **Master Plan Update**

- a. Master Plan Steering Committee Membership Update & Nomination of Pamela Russell-Slack
- b. Project Updates

X. **Staff Updates**

XI. **New Business**

XII. **Upcoming Dates of Interest**

- Joint Committee of the Planning Board and PLD – March 11<sup>th</sup>, 6:30 PM
- Planning Board Steering Committee – March 12<sup>th</sup>, 11:00 AM
- Planning Board Site Visit – March 20<sup>th</sup>, 8:00 AM – To Be Confirmed
- Planning Board Meeting – March 25<sup>th</sup>, 6:30 PM

1 City of Keene  
2 New Hampshire

3  
4  
5 PLANNING BOARD  
6 MEETING MINUTES  
7

8 **Monday, January 22, 2024**

**6:30 PM**

**Council Chambers,  
City Hall**

**Members Present:**

Harold Farrington, Chair  
Roberta Mastrogiovanni, Vice Chair  
Mayor Jay V. Kahn  
Councilor Michael Remy  
Armando Rangel  
Ryan Clancy  
Kenneth Kost

**Staff Present:**

Jesse Rounds, Community Development  
Director  
Mari Brunner, Senior Planner  
Evan Clements, Planner

**Members Not Present:**

Randyn Markelon, Alternate  
Gail Somers, Alternate  
Tammy Adams, Alternate

9  
10 **I) Call to Order**

11 Chair Farrington called the meeting to order at 6:30 pm and a roll call was taken. Chair Farrington  
12 recognized Mr. Kost for recently becoming a regular voting member of the Board. He also  
13 recognized Mayor Kahn who will also serve as a regular voting member during his time as Mayor.  
14

15 **II) Minutes of Previous Meeting – December 18, 2023**

16 Chair Farrington offered the following correction: add the word “Senate” after the word “State”  
17 on line 248.  
18

19 The Mayor asked whether he should be voting on a set of minutes for a meeting at which he was  
20 not present. Councilor Remy stated it has always been the practice of members to vote on minutes  
21 regardless of whether they were present or not. Ms. Brunner stated the Mayor could abstain if he  
22 wanted to, but it is up to him whether he wants to vote or not.  
23

24 A motion was made by Councilor Michael Remy that the Planning Board approve the December  
25 18, 2023 meeting minutes as amended. The motion was seconded by Roberta Mastrogiovanni and  
26 was unanimously approved. The Mayor participated in the vote on this item.  
27

28 **III) Election of Chair, Vice Chair, & Steering Committee**

29 A motion was made by Councilor Michael Remy to nominate Harold Farrington as Chair of the  
30 Board. The Councilor noted that Mr. Farrington has been on the Board since 2021, starting as an

31 Alternate and then started serving as a regular voting member in 2022. The motion was seconded  
32 by Roberta Mastrogiovanni.

33

34 A motion was made by Councilor Michael Remy to nominate Roberta Mastrogiovanni as Vice-  
35 Chair of the Board and he noted that she has been a regular voting member since 2021. The motion  
36 was seconded by Harold Farrington.

37

38 A motion was made by Councilor Michael Remy to nominate Armando Rangel as the third  
39 member of the Planning Board Steering Committee and he noted that he started as an alternate in  
40 2022 and later started serving as a regular voting member a few months later. The motion was  
41 seconded by Roberta Mastrogiovanni.

42

43 The nominations were unanimously approved.

44

45 **IV) Final Vote on Conditional Approvals**

46 The Chairman stated this is a new standing agenda item in response to a recent decision issued by  
47 the NH Supreme Court. As a matter of practice, the Board will now issue a final vote on all  
48 conditionally approved plans after all of the “conditions precedent” have been met. This final vote  
49 will be the final approval for the application and will start the 30-day appeal clock.

50

51 Ms. Brunner stated there are three applications ready for final approval tonight. The first one is S-  
52 11-23. This was a boundary line adjustment and street access permit application for 143 and 147  
53 Main Street and 0 Davis Street. There were five conditions precedent for this application, including  
54 the submittal of a plan that with the owner's signature; the inspection of the lot monuments by the  
55 Public Works Director or their designee; the submittal of four full-size paper, two mylar and a  
56 digital copy of the final plan set; the submittal of a check to cover the cost of recording fees; and  
57 the submittal of an updated plan showing the revised driveway configuration with a nine-foot wide  
58 section with protective bollards.

59

60 All of those conditions precedent have been met.

61

62 A motion was made by Councilor Michael Remy that the Planning Board issue final approval for  
63 S-11-23. The motion was seconded by Roberta Mastrogiovanni and was unanimously approved.

64

65 Ms. Brunner stated that the next application is S-09-23 for a 3-lot subdivision of 284 West Surry  
66 Road. The conditions precedent included the following: that the owner’s signature appears on the  
67 plan; the inspection of lot monuments; the submittal of subdivision approval from the New  
68 Hampshire Department of Environmental Services (one of the lots was less than five acres and it  
69 required DES approval for the septic system); the submittal of four full-size, two mylar and a  
70 digital copy of the final plan set; and the submittal of a check to cover recording fees. All of these  
71 precedent conditions of approval have been met.

72 A motion was made by Councilor Michael Remy that the Planning Board issue final approval for  
73 S-09-23. The motion was seconded by Roberta Mastrogiovanni and was unanimously approved.

74

75 Mayor Kahn asked where in the agenda packet he could find these materials. Ms. Brunner  
76 explained that the materials for the final approval of an application are sometimes submitted on  
77 the day of the Planning Board meeting. Instead of holding up the project for another month, that  
78 information is brought to the meeting. The materials for the applications are in the agenda packet  
79 for the meeting where the project was conditionally approved. For example, the item just discussed  
80 was conditionally approved at the October 2023 meeting.

81  
82 Ms. Brunner stated she would like to recommend tabling this item until the Board votes on the  
83 extension request. This is for the site plan application, SPR-790, for an addition to Summit  
84 Packaging at 7 Krif Ct. She went on to say the reason there is both an extension request and a final  
85 approval for the same application tonight is because their conditional approval for the application  
86 expired prior to this meeting, but they have now met their conditions for final approval.

87  
88 **V) Extension Requests**

- 89  
90 **1. SPR-897, Modification #1 & SWP-CUP-04-21 – Site Plan & Surface Water**  
91 **Conditional Use Permit – U-Haul of South Keene, 472 Winchester St – Applicant**  
92 **Fieldstone Land Consultants, on behalf of owner Amerco Real Estate Company,**  
93 **requests a first extension to the deadline to achieve active and substantial**  
94 **development for the Site Plan & Surface Water CUP applications, SPR-897**  
95 **Modification #1 1 & SWP-CUP-04-21, for the renovation of two existing buildings,**  
96 **the construction of a ~12,175 sf building, and the installation of ~28,900 sf of pre-**  
97 **fabricated storage units on the new U-Haul of South Keene site at 472 Winchester St**  
98 **(TMP #115-020-000). The parcel is 7.38 ac and is located in the Industrial District.**  
99

100 Mr. Chad Branon of Fieldstone Land Consultants addressed the Board. Mr. Branon stated they are  
101 looking for a one-year extension to the deadline for active and substantial development for this  
102 project, as they are still working on acquiring permits from FEMA due to work next to Ash Swamp  
103 Brook at the rear of the site.

104  
105 Mayor Kahn asked when the timeframe for the one-year extension would begin. Ms. Brunner  
106 stated it is dated from the day after the date of conditional approval. Active and substantial  
107 development begins two years from the day after conditional approval and the extension would  
108 extend it out another year. The conditional approval for this application expired on December 21,  
109 2023. Mr. Branon noted that FEMA's review and approval process is lengthy. He added that  
110 construction for Phase 1 has already started. The Mayor clarified that the applicant has the  
111 necessary approval to begin their business at this site and the application is for an addition to this  
112 site. Mr. Branon stated the site plan is approved and the portion being discussed is the self-storage  
113 buildings located at the rear of the site and the FEMA permitting associated with work in that  
114 location is the reason for the extension request.

115  
116 A motion was made by Councilor Michael Remy that the Planning Board extend the active and  
117 substantial development deadline by one year. The motion was seconded by Roberta  
118 Mastrogiovanni and was unanimously approved.

119

- 120       **2. SPR-790, Modification #1 – Site Plan – Summit Packaging Addition – Applicant**  
121       **Keach-Nordstrom Associates Inc., on behalf of owner Summit Packaging Systems**  
122       **LLC, requests a second extension to the deadline to satisfy the precedent conditions**  
123       **of approval for the Site Plan application, SPR-790 Modification #1, for the**  
124       **construction of a ~6,400 sf addition to the existing ~6,250 sf Summit Packaging**  
125       **Systems building and associated site modifications. The parcel is 1.98 ac and is located**  
126       **in the Industrial District.**

127  
128 Ms. Bridget Souza of Keach-Nordstrom Associates addressed the Board next. Ms. Souza stated  
129 their first extension for this application expired on January 19, 2024. The first extension was  
130 approved on July 24, 2023 because of a significant increase in project costs. They are now applying  
131 for another extension because they had not met their precedent conditions of approval yet. Since  
132 then, they have satisfied the two conditions of approval, which were submitting a security for the  
133 cost of sediment and erosion control measures and the submittal of as-built plans, as well as the  
134 submittal of five paper copies and one digital copy of the final plan set.

135  
136 A motion was made by Councilor Michael Remy that the Planning Board grant a six-month  
137 extension to the deadline to satisfy the precedent conditions of approval. The motion was seconded  
138 by Roberta Mastrogiovanni and was unanimously approved.

139  
140 Mr. Clancy noted the Board packet indicates this is a first extension request and asked for  
141 clarification from staff. Ms. Brunner noted that is an error and should indicate that this is a second  
142 extension request.

143  
144 Ms. Brunner went on to say the Planning Board initially approved this application at its meeting  
145 on January 23, 2023 with the two conditions precedent. The first one was the submittal of a security  
146 for sedimentation and erosion control and as-built plans in a form and amount acceptable to the  
147 City Engineer. The second was the submittal of five full-sized paper copies and one digital copy  
148 of the final plan set. Both of these conditions have been met.

149  
150 A motion was made by Councilor Michael Remy that the Planning Board issue final site plan  
151 approval for SPR-790, Modification #1. The motion was seconded by Roberta Mastrogiovanni  
152 and was unanimously approved.

153  
154 **VI). Public Hearings**

- 155  
156       **1. SPR-03-19, Modification #3 – Site Plan – Keene Mini Storage New Building, 678**  
157       **Marlboro Rd - Applicant SVE Associates, on behalf of owner Keene Mini Storage**  
158       **LLC, proposes to construct a ~5,200 sf climate-controlled storage building on the**  
159       **property at 678 Marlboro Rd (TMP #241-107-000). The parcel is 9.5 ac and is located**  
160       **in the Industrial District.**

161  
162       **A. Board Determination of Completeness**

163 Planner, Evan Clements, addressed the Board and stated the applicant has requested exemptions  
164 from submitting a landscaping plan, lighting plan, traffic analysis, soil analysis, historic evaluation,  
165 screening analysis, and an architectural and visual appearance analysis. After reviewing each

166 request, staff recommend that the Board grant the requested exemptions and accept the application  
167 as “complete.”

168  
169 A motion was made by Councilor Remy to accept application, S-09-23, as “complete.” The motion  
170 was seconded by Roberta Mastrogiovanni.

171  
172 Mayor Kahn asked for added clarification on the exemptions. Mr. Clements explained the  
173 applicant has requested an exemption from submitting a landscaping plan as there is no  
174 landscaping being proposed. An exemption has also been requested from submitting a lighting  
175 plan. He explained that there is some wall lighting proposed over the doors, but explained that this  
176 lighting is very much internal to the site and is not lighting the parking lot. Hence, the Planning  
177 Board’s lighting standards do not apply. He went on to state that an exemption was also requested  
178 from submitting a traffic analysis – they did provide a rough estimate of traffic, which Mr.  
179 Clements stated he will discuss later, but the expected impact does not meet the threshold where a  
180 full traffic study would be required.

181  
182 They also requested an exemption from submitting a soil analysis, which staff does not feel is  
183 necessary because they have no concerns about large-scale underground drainage or subsurface  
184 disposal systems. Additionally, a historic evaluation is not necessary as there are no notable  
185 historic features that are being disrupted. The Applicant also requested an exemption from  
186 submitting a screening analysis, which ties into the landscaping plan; however, the proposed  
187 addition is very internal to the site and will be obscured from the public right-of-way by the  
188 existing building and infrastructure. The final exemption request was related to the submittal of an  
189 architectural and visual appearance analysis – Mr. Clements noted that this addition will be a steel  
190 prefabricated building with no notable architectural features and stated that it is ultimately up to  
191 the Board to decide if this addition meets their standards.

192  
193 The motion was made by Councilor Remy, seconded by Roberta Mastrogiovanni, and was  
194 unanimously approved.

195  
196 **B. Public Hearing**  
197 Mr. Rob Hitchcock of SVE Associates addressed the Board on behalf of Keene Mini Storage. He  
198 indicated that the proposed addition is a 5,200 square foot building in some empty space on the  
199 site. This would be a climate-controlled building with a canopy over the center front. There will  
200 be egress doors on each end of the building because there are interior alleys. The entire site is  
201 fenced today and the fencing will be extended to include this building as well. Mr. Hitchcock  
202 indicated there is no water, sewer, dumpster, or landscaping included as part of this proposal. There  
203 will be two lights located under the entry canopy, and there will also be a concrete tank with a 12-  
204 inch pipe going in and a 6-inch pipe coming out to reduce runoff. There will be no increase to  
205 runoff to the river that is adjacent to this site. This concluded Mr. Hitchcock’s comments.

206  
207 The Mayor asked whether there were underground storage tanks located on this site in the past.  
208 Mr. Hitchcock stated he was not aware of any tanks on this site. He noted that there is a gas tank  
209 that has been on the site for over 30 years.

210

211 Mr. Kost asked how the applicant will make sure that no hazardous material is stored in any of  
212 these storage units. Mr. Hitchcock stated he hoped the owner would review that such materials  
213 cannot be stored in any of the units, but noted that he wasn't sure how that would be governed and  
214 felt it would be similar to any of the other storage units in Keene. Mr. Kost stated he was concerned  
215 because of this site's close proximity to the river  
216

217 Staff comments were next. Mr. Clements addressed the Board and stated this is an existing 9.5-  
218 acre lot located on the north of Route 101 with Graves Rd to the southeast and Thompson Rd to  
219 the west. The property contains several buildings that contain office, storage, and warehousing  
220 uses. An existing fueling station also exists on the property. Keene Mini Storage offers both drive-  
221 up storage units and climate-controlled storage units. The purpose of this application is to construct  
222 a free standing 5,200-sf building on the existing the site in order to create additional climate-  
223 controlled storage units available to rent. The proposal includes the creation of six additional  
224 parking spaces and associated drainage improvements to accommodate the new building and  
225 parking area.  
226

227 Mr. Clements went on to say that after reviewing the application, staff has made a preliminary  
228 evaluation that the proposed site plan does not appear to have the potential for regional impact as  
229 defined by RSA 36:55. He indicated the Board will need to make a final determination as to  
230 whether the proposal, if approved, could have potential for regional impact.  
231

232 With reference to Drainage: Mr. Clements stated the plan proposes the installation of roof drains,  
233 stone infiltration strips around the building, and catch basins to capture new stormwater flow  
234 generated by the new building. The new catch basins will be tied into the existing underground  
235 drainage system on site. The submitted drainage summary states that the proposal will not create  
236 any adverse impacts to downstream properties due to stormwater runoff from the proposed  
237 improvements. It appears that this standard has been met.  
238

239 Sediment & Erosion Control: The Applicant states in their narrative that silt fencing will be  
240 installed to contain sediment runoff and the construction contractor will install, monitor, and repair  
241 all erosion control measures on a regular basis. The proposed site disturbance will be internal to  
242 the property and the risk of sediment runoff onto adjacent properties or surface waters is minimal.  
243 Mr. Clements stated this standard has been met.  
244

245 Snow Storage & Removal: The Applicant states in their narrative that there is sufficient snow  
246 storage space available on site. This standard has been met.  
247

248 Landscaping: This standard is not applicable – no new landscaping is being proposed.  
249

250 Screening: No new screening is proposed with this application. The proposed building is internal  
251 to the site and will be obscured by existing buildings that are closer to the public right-of-way.  
252

253 Lighting: The proposal includes the installation four wall pack light fixtures – one above each  
254 door. A 16'x22' canopy is proposed at the main entrance to the new building. The canopy will  
255 have light fixtures installed underneath that are recessed at the edge of the canopy and hence meets  
256 the Board's lighting standards. The wall pack fixtures proposed by the Applicant have a Color



257 Rendering Index (CRI) of 70, where a CRI greater than 70 is required by the Board's lighting  
258 standards. A precedent condition of approval related to the submittal of a wall pack lighting  
259 cutsheets that meet this standard is suggested by staff.

260  
261 Sewer & Water: Neither is being proposed; hence, this standard is not applicable.

262  
263 Traffic & Access Management: The Applicant states in their narrative that mini storage units are  
264 very low traffic generators. Vehicle counts can be tracked and estimated from gate openings, which  
265 is done automatically. Based on the existing site utilization, the Applicant estimates that there are  
266 less than 10 vehicles accessing the upper-level storage units on any given weekday. That number  
267 increases to 20 vehicles on Saturday. The Applicant estimates that the proposal will increase  
268 weekday vehicles to 15 and Saturday vehicles to 25. Mr. Clements stated City engineering staff  
269 did request that the Applicant contact New Hampshire Department of Transportation to see if they  
270 had concerns about the increase in site traffic and access off New Hampshire Route 101. DOT did  
271 respond to the applicant in an email, which the Board has copies of. DOT did not have any concern  
272 with respect to the increase in traffic generation and noted that it might be time to update the  
273 permit, but this will be between the applicant and DOT.

274  
275 Parking Spaces: The proposal includes the addition of four regular spaces and two accessible  
276 parking spaces for a total of six new parking spaces for the building. Bollards are proposed to act  
277 as vehicle stops at the end of each parking space. The associated drive aisle is of sufficient width  
278 to accommodate the new parking spaces and all parking meets zoning. A walking path is provided  
279 between the parking spaces, the existing building, and the proposed building in order to provide a  
280 protected walkway between the new parking spaces and the proposed building. It appears this  
281 standard has been met.

282  
283 Filling and Excavation: The Applicant states in their narrative that fill will be used to create the  
284 building platform and slopes. Site access for the property is from Route 101 and traffic impacts  
285 due to the hauling of fill will not adversely impact the surrounding area. It appears that this standard  
286 has been met.

287  
288 Surface Waters and Wetlands: The Applicant states in their narrative that the proposal will not  
289 impact existing surface waters and there are no wetlands located on the property. The property is  
290 exempt from NHDES Shoreland Protection regulations due to its historically built-up nature, and  
291 the proposed new building and site modifications are located outside the 30-ft surface water  
292 protection buffer. This standard has been met.

293  
294 Hazardous and Toxic Materials: The Applicant states in their narrative that there will not be any  
295 hazardous or toxic materials stored on site. Mr. Clements stated in reference to the question raised  
296 by the Board, he can only speculate that the lease agreement for the units would include a provision  
297 for hazardous and toxic materials based on the applicant's statement.

298  
299 Noise: The Applicant states in their narrative that the proposed expansion of the existing mini  
300 storage operation will not generate any new noise. Mr. Clements noted his department has not  
301 received any noise complaints for this site and that he believes this standard has been met.

302

303 Architecture and Visual Appearance: The Applicant states in their narrative that the proposed  
304 architectural and visual appearance of the new building will match the existing climate-controlled  
305 storage buildings on the site. The proposed building will have corrugated metal walls with a metal  
306 rigid awning over the main entrance. The building will be 80-ft wide, and the awning will be 22-  
307 ft wide. Mr. Clements stated the most applicable sub-section of this standard that he could refer to  
308 is Section 20.14.3.E, which states that, “*A cohesive visual character shall be maintained within a*  
309 *development through the use of coordinated hardscape (e.g. paving materials, lighting, outdoor*  
310 *furniture, etc.) and landscape treatments.*” He indicated the Board will need to determine if the  
311 architectural standard for this proposal has been met.

312  
313 Mr. Clements next reviewed the proposed motion.

314  
315 Mr. Clements asked Mr. Hitchcock where the fuel for the fueling station on site comes from.  
316 Councilor Remy stated he wasn’t sure if Mr. Hitchcock would be prepared to speak to the  
317 underground tanks, as they are located on the other side of the site; there are two tanks - one for  
318 gas and one for diesel, both made out of fiberglass, which were installed in 2017.

319  
320 This concluded staff comments.

321  
322 Mr. Clancy asked how the Board could learn about the criteria staff uses in deciding whether or  
323 not to grant exemptions from submittal requirements for applications. Mr. Clements stated the  
324 exemptions are related to Article 25, which outlines the application submittal requirements for the  
325 various types of applications. He explained that the applicant submits the most pertinent  
326 information that they feel is necessary for staff and Planning Board review of the application. They  
327 will then request exemptions from materials listed in Article 25 that they don’t believe are relevant.  
328 At that point, staff makes a determination that they either agree or don’t agree. If staff does not  
329 agree, they ask for more information.

330  
331 For example, the applicant asked for an exemption from submitting a drainage analysis for this  
332 application. The engineering team asked for rationale from the applicant as to why they were  
333 asking for an exemption from submitting this item. The applicant responded by submitting one.  
334 Ms. Brunner noted Article 25, Section 12 of the Land Development Code talks about site plan  
335 review and outlines the required submittal items. She noted that the exemptions that staff goes  
336 through are recommendations. Ultimately, it is the Board who must decide that an application is  
337 complete and whether or not to grant the requested exemptions.

338  
339 Chair Farrington asked if staff could look into how self-storage operators minimize the risk of the  
340 storage of hazardous and toxic materials, rather than just trusting what their customers indicate.  
341 Mr. Clements stated he was not sure how the issue of privacy is addressed at self-storage locations,  
342 but stated that staff can look into this.

343 Mr. Clancy asked when the last soil analysis was done on this site. Mr. Hitchcock stated soil  
344 analyses are usually requested if there are wetlands on a site or if a septic system is going to be  
345 installed. He added that a soil analyses is not required as part of a site plan, but stated that believes  
346 is required for a building permit. Mr. Clements felt that a soil analysis could be required based on  
347 what is being constructed on a site. He added that for staff’s review, it is mostly what Mr.

348 Hitchcock described – it is for wetlands, drainage rates for percolation, stormwater management  
349 systems, subsurface disposal systems, leech fields, etc.

350  
351 He added he wasn't sure if this site has ever had a comprehensive soil analysis, considering it has  
352 been industrial and built out for so long. He went on to say that the fact that it has been exempted  
353 by NH DES from Shoreland Protection requirements is a relatively significant indication as to how  
354 impervious and built-out the site has been for a long period of time. Mr. Hitchcock added that the  
355 fuel tank is centered inside a concrete bunker and is designed to hold 100% of the volume should  
356 the tank ever leak. He further stated that the site has been run and maintained by Cheshire Oil for  
357 at least the last 35 years.

358  
359 The Chair asked for public comment next. With no comment from the public, the public hearing  
360 was closed.

361  
362 C. Board Discussion and Action

363 A motion was made by Councilor Michael Remy that the Planning Board approve SPR-03-19,  
364 Mod. 3, as shown on the plan identified as “Keene Mini Storage Expansion 2023/2024” prepared  
365 by SVE Associates at a scale of 1 in. = 20 ft. dated December 18, 2023 and the architectural  
366 elevations prepared by SVE Associates with no scale dated December 18, 2023 with the following  
367 conditions:

- 368  
369 1) Prior to final approval and signature by the Planning Board Chair, the following conditions  
370 precedent shall be met:
- 371 a) Owner's signature appears on the plan set.
  - 372 b) Submittal of security for sedimentation and erosion control and “as built” plans in a form  
373 and amount acceptable to the City Engineer.”
  - 374 c) Submittal of a revised lighting cut sheet for wall packs with a CRI of greater than 70 and a  
375 revised drainage summary with the P.E. stamp on it.
  - 376 d) Submittal of five full-size paper copies and one digital copy of the final plan.
- 377  
378 2) Subsequent to final approval and signature by the Planning Board Chair, the following  
379 conditions shall be met:
- 380 a) Prior to the commencement of site work, the Community Development Department shall  
381 be notified when all erosion control measures are installed and the Community  
382 Development Director, or their designee, shall inspect the erosion control measures to  
383 ensure compliance with this site plan and all City of Keene regulations.”
- 384

385 Councilor Remy stated that he did not feel as though there would be any regional impact from this  
386 project. The motion was seconded by Roberta Mastrogiovanni and was unanimously approved.

- 387  
388 **2. PB-2024-01 – Surface Water Protection Conditional Use Permit – 186 Gunn Rd -**  
389 **Applicants and owners Ashley & Peter Greene request a reduction in the Surface**  
390 **Water Protection buffer from 75' to 30' to allow for the future subdivision and**  
391 **development of the parcel at 186 Gunn Rd (TMP #205-013-000). The parcel is 11 ac**  
392 **and is located in the Rural District.**

393

394 A. Board Determination of Completeness

395 Planner, Evan Clements, addressed the Board and stated that the applicant requests exemptions  
396 from submitting a landscaping plan, lighting plan, building elevations, drainage report, historic  
397 evaluation, screening analysis, and an architectural and visual appearance analysis. After  
398 reviewing each request, staff recommend that the Board grant the requested exemptions as they  
399 have no bearing on the merits of the application and accept the application as “complete.”  
400

401 A motion was made by Councilor Remy to accept application, PB-2024-01, as “complete.” The  
402 motion was seconded by Roberta Mastrogiovanni and was unanimously approved.  
403

404 B. Public Hearing

405 Mr. Jason Bolduc of Meridian Land Services addressed the Board. Mr. Bolduc stated that the intent  
406 of the applicants is to subdivide off the eastern portion of their property. During a wetlands  
407 delineation, it was discovered that there was significant amount of wetlands present on the site.  
408 This resulted in having to reduce the surface water buffer to make the proposed parcel suitable for  
409 development. He referred to an exhibit showing the site layout for a typical four bedroom house  
410 with a septic, well, and driveway. To accommodate a reduction in the buffer, the applicant is  
411 proposing infiltration trenches along the front and rear of the proposed dwelling to capture runoff  
412 from the roof, as well as plantings around the edge of the proposed buffer to assist with soil erosion  
413 control and to act as a natural buffer.  
414

415 Mr. Bolduc went on to say that Best Management Practices will be used during construction, and  
416 stated that they propose to install erosion control measures before construction commences and  
417 keep them in place until there is a healthy level of vegetation throughout the developed area. This  
418 concluded the applicant’s presentation.  
419

420 Mayor Kahn noted the Conservation Commission asked for additional time to address the buffer  
421 reduction request and asked for staff or the applicant’s input. Mr. Bolduc agreed that the  
422 Conservation Commission requested more time. He indicated that due to the snowstorm, he could  
423 not attend the meeting in person, but joined remotely. As a result, the site visit was also postponed.  
424 Ms. Brunner added that there was a lot of discussion undertaken at the Conservation Commission  
425 meeting regarding this item and noted that this is the first time the Commission has had to review  
426 a buffer reduction, which is a new option in the City’s regulations. It went into effect when the  
427 Land Development Code went into effect in September 2021.  
428

429 She indicated that because the Conservation Commission could not participate in a site visit and  
430 this is the first time they have had to review such a request, one of the concerns voiced is that the  
431 standards for Surface Water Conditional Use Permits state that “*the proposed use and or activity*  
432 *cannot be located in a manner to avoid encroachment to the Surface Water Protection Overlay*  
433 *District*”  
434

435 Ms. Brunner noted the applicant is proposing to subdivide two acres from the existing 11-acre  
436 parcel of land and the Commission asked the applicant whether they have looked at any other areas  
437 on their parcel or if they could make the lot bigger to avoid potential impacts to the buffer. She  
438 noted that the applicant could not address that question because other options have not been looked  
439 at yet. She indicated the Conservation Commission did submit a letter to the Planning Board.

440

441 One of the property owners, Ashley Greene, stated they have considered other sections of their  
442 property for subdivision. However, due to the slope of Gunn Road if the other side was to be  
443 subdivided, that area would be visible from their home. There are also easements that run along  
444 the western border for a neighbor and for the power company. She also distributed photographs of  
445 the property to include the eastern and western property line. She noted the pink area circled on  
446 the photographs are the wetland areas.

447

448 Mr. Bolduc stated that he is a certified wetlands scientist and he flagged the wetlands and did an  
449 assessment. He indicated that the wetlands are created from a CB side slope off Gunn Road that  
450 intercepts the seasonal high water table. Performing a functions and values evaluation of the  
451 wetlands, they did not meet any criteria for a high value wetland. He added that at least 400 feet  
452 down slope through a natural forest, there is a stream. Provisions in the plan are being taken to  
453 prevent anything from happening to that stream.

454

455 Staff comments were next. Mr. Clements stated he wanted to start with the conditional use permit  
456 section of the LDC and reminded the Board of some criteria.

457

458 In reference to the buffer reduction, the standards state that, *“In specific cases, the Surface Water  
459 Protection District buffer area may be reduced to 30-ft in zoning districts requiring a 75-ft buffer  
460 and to 10-ft in zoning districts requiring a 30-ft buffer, at the discretion of the Planning Board,  
461 and if the applicant provides extraordinary mitigation, replication, and/or restoration of surface  
462 waters and wetlands, and/or open space preservation measures.”*

463

464 He noted that Section 11.6 of the LDC outlines activities that are subject to Surface Water  
465 Protection Conditional Use Permit applications and explained that this application will be for the  
466 future potential subdivision of this lot to create a new residential building lot. Although a  
467 subdivision application is not before the Board this evening, he noted that the CUP standards state  
468 that a Surface Water CUP is required prior to or in conjunction with the review of a subdivision  
469 if, *“it is for the creation of new lots by subdivision that would require the disturbance or crossing  
470 of lands within the surface Water Protection Overlay District.*

471

472 He noted that without the buffer reduction, the proposed 2.26-acre lot is completely covered by  
473 the wetland buffer and is not viable for development. The standard discusses the creation of a new  
474 lot where access to that lot would require crossing the buffer. Staff also had concerns, as did the  
475 Conservation Commission, related to attempting to cite this new lot somewhere else on the  
476 property where the impact to the wetlands and the wetlands buffer would be reduced, or if this  
477 proposed location will truly have the least amount of impact possible.

478

479 Mr. Clements went on to say that the subject parcel is an existing 11.26-acre lot located on the  
480 north side of Gunn Road, approximately 1,200 feet from the Gilsum town line. The Sturtevant  
481 Brook runs adjacent to the rear of the property. The lot contains an existing 1,900-sf single-family  
482 residence and a detached 1,320-sf pole barn. An initial wetlands delineation has revealed that a  
483 significant portion of the lot consists of wetland systems. The purpose of this application is to seek  
484 a Surface Water Protection Conditional Use Permit for a surface water buffer reduction from 75

485 feet to 30 feet and 10,870 sf of impact to the reduced buffer to accommodate the future subdivision  
486 of a new 2.26-acre residential building lot.

487  
488 Mr. Clements further stated that a Conditional Use Permit is required per Section 11.3.1.C of the  
489 LDC for a buffer reduction and per Section 11.6 for the construction of a new structure that impacts  
490 the buffer, the creation of a new lot that would require buffer disturbance to access, and for the  
491 construction of a new driveway that will impact the buffer. The submitted exhibit plan shows a  
492 single-family residential development on the future lot that depicts a well, septic, drainage,  
493 driveway, and residence. Per Section 11.6.3.A of the Land Development Code, this application  
494 was referred to the Conservation Commission for review and recommendation at their meeting on  
495 January 16<sup>th</sup>. Their recommendation is to continue this application to the February Planning Board  
496 due to their site visit being postponed because of the weather.

497  
498 With respect to regional impact, staff has made a preliminary evaluation and does not believe that  
499 this proposal meets the threshold of regional impact. However, the Planning Board will need to  
500 make a final determination for that.

501  
502 Mr. Clements then reviewed the Application Analysis:

503  
504 *A. The proposed use and/or activity cannot be located in a manner to avoid encroachment*  
505 *into the Surface Water Protection Overlay District.*

506  
507 He noted that other constraints such as easements, access, visual concerns were discussed earlier.  
508 The Applicant states in their narrative that the proposed use cannot be located in a manner that  
509 avoids encroachment on the lot. The subdivision of the proposed lot has not been submitted. It  
510 may be possible to increase the proposed lot area to further reduce the proposed impact. The Board  
511 may wish to ask the applicant to explore this option. He went on to say that the Applicant has also  
512 not proposed any permanent measures to prevent future impacts to the buffer or wetlands after  
513 initial development. The Board will need to determine if this standard has been met.

514  
515 *B. Encroachment into the buffer area has been minimized to the maximum extent possible,*  
516 *including reasonable modification of the scale or design of the proposed use.*

517  
518 The Applicant states in their narrative that the exhibit plan depicts a 32'x26' 4-bedroom dwelling,  
519 septic system, and wellhead that do not encroach into the buffer. Further discussion with the  
520 applicant revealed that the total buffer impact will be 10,870 sf. This includes 3,080 square feet of  
521 impact for the driveway and 7,790 square feet of impact for the dwelling, wellhead, septic, and  
522 associated grading. The Board will need to determine if this standard has been met.

523  
524 *C. The nature, design, siting, and scale of the proposed use and the characteristics of the site,*  
525 *including but not limited to topography, soils, vegetation, and habitat, are such that when*  
526 *taken as a whole, will avoid the potential for adverse impacts to the surface water resource.*

527  
528 The Applicant states in their narrative that the site has been designed to have no structures within  
529 30' of the wetlands edge in order to prevent adverse impacts to the wetlands. Mr. Clements  
530 indicated to Mr. Bolduc that he will be looking for clarification about his original narrative. It was

531 originally stated that there will be no impacts besides the driveway; however, further discussions  
532 made it sound like there would be impacts. Mr. Clements indicated the staff report was written on  
533 the assumption of what the narrative provided to staff, but that conversations with the applicant  
534 have changed this assumption.

535  
536 He went on to state that the dwelling will have infiltration trenches to collect runoff from the roof  
537 of the dwelling and that stormwater management for the driveway is not shown on the exhibit plan.  
538 The narrative states that Red Spruce trees are proposed along the edge of grading to aid in soil  
539 stability and buffer identification. The Board will need to determine if this standard has been met.

540  
541 *D. The surface water buffer area shall be left in a natural state to the maximum extent*  
542 *possible. The Planning Board may establish conditions of approval regarding the*  
543 *preservation of the buffer, including the extent to which trees, saplings and ground cover*  
544 *shall be preserved.*

545  
546 The Applicant states in their narrative that the buffer will remain in its natural state except for the  
547 required impacts due to site development. Erosion control measures will be installed prior to site  
548 development and maintained throughout the development process. Red Spruce trees will be  
549 installed along the edge of grading to provide a natural barrier along the buffer and to provide soil  
550 stabilization. The Board will need to determine if this standard has been met.

551  
552 *E. The Planning Board may consider the following to determine whether allowing the*  
553 *proposed encroachment will result in an adverse impact on the surface water resource.*

554  
555 *1. The size, character, and quality of the surface water and the surface water buffer being*  
556 *encroached upon.*

557  
558 The Applicant states in their narrative that the wetlands are palustrine (marshy), forested, saturated  
559 and not to be impacted. Using the “Highway Methodology,” a wetlands evaluation was conducted  
560 and found that the wetlands adjacent to the building area have no suitable wetland functions or  
561 values of significant importance. The Board may wish to ask the applicant to provide additional  
562 context as to the importance of the wetland, such as wildlife habitats and status as vernal pools.

563  
564 *2. The location and connectivity of the surface water in relation to other surface waters*  
565 *in the surrounding watershed.*

566  
567 The Applicant has stated in their narrative that the wetlands complex drains to a stream over 400  
568 feet down slope. The entire wetlands system on the parent lot and the proposed lot have been  
569 delineated, but not shown on the plan provided to staff. The full connectivity of the system has not  
570 been evaluated. The Board may want to consider asking for additional information from the  
571 applicant to better understand the nature of the wetland system.

572  
573 *3. The nature of the ecological and hydrological functions served by the surface water.*  
574

575 The Applicant has stated in their narrative that, based on the evaluation, the associated wetlands  
576 area is of low value. The vegetation density is low, which is why the Applicant proposes to install  
577 trees to aid in soil stability and buffer identification.

578  
579 4. *The nature of the topography, slopes, soils, and vegetation in the surface water buffer.*  
580

581 The Applicant has stated in their narrative that the average slope within the buffer is 10% to 15%  
582 with a maximum slope to the rear of the proposed dwelling to be 22%. Test pit data revealed the  
583 soil composition to be fine sandy loam to sandy loam. The vegetation is low in density and mainly  
584 consists of Hemlock, Ash, and Maple with little ground cover.

585  
586 5. *The role of the surface water buffer in mitigating soil erosion, sediment and nutrient*  
587 *transport, groundwater recharge, flood storage, and flow dispersion.*  
588

589 The Applicant states in their narrative that the evaluation revealed that the wetlands serve little  
590 function related to sediment and nutrient transport, groundwater recharge, flood storage, and flow  
591 dispersion.

592  
593 6. *The extent to which the surface water buffer serves as wildlife habitat or travel*  
594 *corridor.*  
595

596 The Applicant has stated that the wetlands is not located within a high-value wildlife habitat,  
597 according to the City's Wildlife Action Plan GIS overlay. The area is considered a supporting  
598 landscape, which is the lowest tier in the overlay (the least valuable according to the City's  
599 assessment). Gunn Road is located adjacent to the wetlands and is a barrier to wildlife migration.  
600 The narrative notes that there is a half mile of natural woodlands behind the subject property that  
601 act as an effective travel corridor.

602  
603 7. *The rate, timing and volume of storm water runoff and its potential to influence water*  
604 *quality associated with the affected surface water or any associated downstream*  
605 *surface waters.*  
606

607 The exhibited submitted by the Applicant has infiltration trenches proposed along the proposed  
608 dwelling to mitigate stormwater runoff. No stormwater management is proposed for the driveway.  
609 The Application states that the stream that the wetlands drain to is greater than 400 feet away. Mr.  
610 Clements noted that as the applicant has noted previously, there is plenty of room between the  
611 proposed area and the stream.

612  
613 8. *The sensitivity of the surface water and the surface water buffer to disruption from*  
614 *changes in the grade or plant and animal habitat in the buffer zone.*  
615

616 The Applicant states in their narrative that sedimentation and erosion control measures are  
617 proposed to remain in place until soils have been stabilized with a healthy growth of vegetation.  
618 Plantings along the buffer are proposed to aid in stabilization and to help define the buffer  
619 permanently. The narrative notes that the areas to the rear of the lot are to remain unaltered to  
620 allow for animal and plant habitat.



621  
622 Mr. Clements went on to say that the Board will need to determine if the mitigation methods  
623 proposed by the Applicant meet the threshold outlined in Section 11.3.1.C of the Land  
624 Development Code, which states, *“In specific cases, the Surface Water Protection District buffer*  
625 *area may be reduced to 30-ft in zoning districts requiring a 75-ft buffer and to 10-ft in zoning*  
626 *districts requiring a 30-ft buffer, at the discretion of the Planning Board, and if the applicant*  
627 *provides extraordinary mitigation, replication, and/or restoration of surface waters and wetlands,*  
628 *and/or open space preservation measures.”*

629  
630 Mr. Clements stated there is a proposed motion if the Board is inclined to approve this application.  
631 However, it is staff’s recommendation that the item be continued to the February meeting giving  
632 the Conservation Commission time to give the Board their recommendation.  
633

634 Mayor Kahn asked whether there would be any impacts to the owner if this item is continued to  
635 next month. Mrs. Greene agreed they have been working on this for a while, but indicated that  
636 they want to move forward in the right way and make sure the all entities involved in this  
637 application have the necessary information.  
638

639 Councilor Remy asked for an example of “extraordinary mitigation”, and would like the  
640 Conservation Commission to be given the opportunity to weigh in on this application. Ms. Brunner  
641 stated this would be staff’s recommendation as well and added that this is a new portion of the  
642 regulations. The ability to reduce the buffer, which is a standard, has been effect since September  
643 2021, but is not something that has ever been used before. As a result, the City does not have what  
644 past applications have considered to be “extraordinary mitigation”. However, at the minimum,  
645 staff would be recommending some sort of runoff and treatment along the driveway, which is  
646 currently not included. She added that some of the items the Conservation Commission discussed,  
647 which the applicant seemed open to, was the creation of a detention basin to protect the higher  
648 value wetlands that are downstream. She felt that the Board should rely on the Conservation  
649 Commission as the content expert.  
650

651 Councilor Remy asked what the normal wetlands buffer would be for a septic or leach field in this  
652 zoning district. Mr. Bolduc stated that for septic systems it is dictated by the state, which requires  
653 a 50-foot setback from the edge of wetlands for a leach field, and a 75-foot protective wellhead  
654 radius from the wellhead and the leach field. It was clarified that those measurements are shown  
655 on the applicant’s plan. Ms. Greene stated that the Conservation Commission had raised concerns  
656 regarding mitigation for the driveway.  
657

658 She indicated their engineering team has worked on additional driveway mitigation and that  
659 information is available tonight. Mr. Bolduc stated that the two impervious areas for this  
660 development would be the roof run off, which will be addressed by infiltration trenches. He  
661 circulated a concept drawing for the Board and staff to review. Councilor Remy stated he will  
662 review this, but if the intent of the Board is to continue this item, then it might be prudent to review  
663 this for next month.  
664

665 Mr. Clancy clarified that this lot has not been subdivided and asked if it was normal procedure to  
666 grant a request as is before the Board before a subdivision occurs. He further questioned that if the

667 request is granted if the entire lot's wetlands buffer is reduced to 30 feet. Mr. Clements indicated  
668 that the Board's regulations require site plans to be reviewed in tandem with a Conditional Use  
669 Permit application. However, the regulations do not require a subdivision to run in tandem with a  
670 Conditional Use Permit application. The applicant would like to hold off on the subdivision due  
671 to the extra time and effort required to prepare a proposed subdivision plat. They would like the  
672 Board's opinion on basically taking the land as it stands now to determine if it is viable for  
673 development or not. However, it could be viable with the buffer reduction. This approval is crafted  
674 to tie to the exhibit plan that is associated with this and would only apply to the new lot.

675  
676 Mr. Bolduc stated it is their intent to focus after doing the wetlands delineation on the parcel and  
677 knowing the owners' intent is to subdivide off the eastern portion of the lot. He added that he asked  
678 survey crews to focus on this area to see if it is viable by producing an exhibit and coming before  
679 the Board before a full boundary survey for the 11 acres is completed. He added that the cost goes  
680 up significantly once they start spending a few days on the site. They wanted to review this option  
681 before a full subdivision is considered.

682  
683 Mr. Clements stated that in his opinion with regards to protecting wetland buffers, the applicant's  
684 proposal for the red spruce is a very creative idea. Having a living protective buffer is moving in  
685 the right direction for what staff could be looking for.

686  
687 With reference to the driveway and the proposal he circulated to the Board, Mr. Bolduc stated the  
688 proposal is for two conveyance swales along each side, directed into three proposed drywalls to  
689 catch the stormwater and the sediment coming off the driveway. He indicated the Conservation  
690 Commission was concerned about the turnaround and why a turnaround was necessary. Mr.  
691 Bolduc explained that for a long driveway to be viable, a turnaround was necessary. This is the  
692 reason for the third drywall on the downslope portion.

693  
694 The Chair asked for public comment. Mr. Clements noted if the Board intends to continue this  
695 application, the public hearing needs to be left open.

696  
697 Chair Farrington read into the record Conservation Commission letter:

698  
699 *"I would give you a little background on the Commission's recommendation to continue the public*  
700 *hearing on the conditional use permit application for 186 Gunn Road. The Commission*  
701 *deliberated the application for about an hour last week, after which we still had a number of*  
702 *questions. Unfortunately, due to the weather, we were unable to perform a site visit to the property,*  
703 *which would have helped answer at least a few of those questions. The Conservation Commission*  
704 *feels that there is a lot riding on this application because it will go a long way towards setting a*  
705 *precedent concerning wetland buffer protection under the relatively new zoning regulations.*  
706 *Assuming the Planning Board agrees to continue the public hearing, we are planning to set up a*  
707 *visit to the site with the applicants and their representative before the February meeting, after*  
708 *which we will be better able to provide the Planning Board with a thorough recommendation.*

709  
710 *Sparky von Polinsky, Chairman of the Conservation Commission."*

711  
712 C. Board Discussion and Action

713 A motion was made by Councilor Michael Remy that the Planning Board continue this application  
714 to the February 26, 2024 Planning Board meeting at 6:30 pm in Council Chambers. The motion  
715 was seconded by Roberta Mastrogiovanni.

716  
717 Mr. Clancy stated he is in agreement to the continuance until the Board receives the Commission's  
718 report, but wanted the applicant to know that he feels they are moving in the right direction.

719  
720 The motion was unanimously approved.

721  
722 **VI) Master Plan Update**

723 Chair Farrington noted the first Steering Committee meeting has been scheduled for February 6<sup>th</sup>  
724 at 6:00 pm. The City has hired Future IQ as the consultant for this project.

725  
726 **VIII. Staff Updates**

727  
728 a. Overview of Administrative and Minor Project approvals issued in 2023

729 Ms. Brunner referred to the Administrative and Minor Project approvals that were issued in 2023.  
730 Administrative Approvals are outlined on page 47 of the Board's packet. There were 22 approvals  
731 issued by staff and three approvals issued by the Minor Project Review Committee listed on page  
732 50 of the packet.

733  
734 Ms. Brunner noted the Site Plan Review regulations include different thresholds that require  
735 different levels of review. The Administrative Planning Review is for projects that don't meet the  
736 threshold for Minor or Major Site Plan Review. Typically, these are projects with either a smaller  
737 square footage of construction, a smaller area of land disturbance, or projects that don't generate a  
738 lot of traffic or other adverse impacts to the surrounding area. Documentation for these projects  
739 can be found on the fourth floor of City Hall, if any Board member or the public needed to review  
740 them.

741  
742 Next, she went on to explain the Minor Project Review Committee. This is a committee that was  
743 established by the Planning Board as allowed under the RSA. As stipulated by the RSA,  
744 membership of the committee is made up of staff, and that committee reviews site plans that are a  
745 little bit more impactful than the Administrative Planning Applications, but don't rise to the level  
746 of Major Site Plan Review. Projects proposing between 1,000 and 5,000 square feet of new  
747 construction would go before the Minor Project Review Committee and above 5,000 square feet  
748 goes before the Planning Board.

749  
750 Ms. Brunner explained that the Minor Project Review Committee meets twice a month. The first  
751 meeting of the month is to review an application and then, if needed, the second meeting is to  
752 continue the review of any applications that were started earlier in the month. She indicated what  
753 staff is finding is that there are not many applications that are coming before this committee either  
754 because the City is a direct a butter or has an easement across the property or because the applicant  
755 needs to request a waiver of some kind, which automatically moves it up to the Planning Board.

756

757 She noted that Applicants that have been able to go through the Minor Project Review Committee  
758 process really appreciate having it as an option. It is a faster and shorter timeframe for review and  
759 they are still considered public hearings that are recorded and posted online.

760  
761 Chair Farrington stated it would be helpful to include the approval date on these applications. Ms.  
762 Brunner agreed they could do that. The Chair asked whether there were any applications that were  
763 rejected. Ms. Brunner answered in the negative and went on to say that there was one project that  
764 was considered, “*void ab initio*.” She explained that the application went to the Minor Project  
765 Review Committee for review and the Committee approved it; however, the application didn’t  
766 meet the necessary zoning regulations, so the Committee didn’t have jurisdiction to approve it. It  
767 was as if the application never happened. It wasn’t necessarily a disapproval, it just meant that the  
768 Minor Project Review Committee couldn’t approve it because it didn’t meet the proper zoning  
769 regulations. She added that all administrative approvals and minor project approvals are also  
770 posted online.

771  
772 The Chair asked where 160 Emerald Street was located. Ms. Brunner stated it the property at the  
773 end of Emerald Street, where the Casino is located. The Mayor noted that he felt the provided list  
774 was helpful.

775  
776 b. Capital Improvement Program (CIP)  
777 Ms. Brunner stated after the December meeting, the CIP timeline came out. The books have been  
778 distributed to Council and are ready for the Planning Board to review. The schedule is listed on  
779 page 51 of the packet. The workshop for the CIP happened last weekend. The Finance Committee  
780 reviews the CIP and Planning Board members are encouraged to attend these meetings. At the  
781 February 26<sup>th</sup> Planning Board meeting, there will be a presentation by the Finance Director and  
782 the Community Development Director. At the end of that meeting, the Board will be asked to take  
783 a vote to recommend the CIP to City Council.

784  
785 Mr. Clancy asked about Board recommendations and how that is handled. Ms. Brunner stated the  
786 Board’s recommendation is to determine whether the CIP is consistent with the existing Master  
787 Plan; however, if the Board has recommendations on specific items, it can be raised at a public  
788 hearing.

789  
790 Mr. Kost asked if as the process moves forward whether there will be changes made to the CIP.  
791 Councilor Remy stated that if there are changes, it is usually that a project will be pushed back or  
792 forward. Ms. Brunner added that the CIP is a financial planning document and until the budget is  
793 adopted by Council, the funding is not approved for any project. This is a document that plans out  
794 how the City will move forward with expenditures.

795  
796 c. Project naming conventions  
797 Ms. Brunner stated staff will be switching to a new naming convention for projects. For instance,  
798 in the past the Board would see “*SPR*” which stands for “*Site Plan Review*” and “*CUP*” which  
799 stands for “*Conditional Use Permit*.” At times there are projects that need multiple applications.  
800 An example would be if someone needs a site plan, but also a Hillside Protection Conditional Use  
801 Permit and a Surface Water Protection Conditional Use Permit. She explained that previously, this  
802 application would have been assigned three project numbers. Staff has been discussing this issue

803 for a while, reviewing the physical and digital filing systems, and tracking projects more clearly.  
804 The new naming convention will be done by project instead of based on the application type. Each  
805 project gets a number and it will then be tagged with the different application types. She indicated  
806 that the old numbering will exist for a while, but noted that moving forward it will change.

807  
808 **IX. New Business**

809 Mr. Clancy stated he would like to see a list of projects ready for final approval prior to the meeting  
810 that lists at which meeting each project received conditional approval. Ms. Brunner stated that this  
811 is an item staff has been debating for quite some time. With the change to doing both a conditional  
812 approval and a final approval, it already creates an extra delay for the project applicant. Previously,  
813 staff could just sign off on conditions of approval once they were met; however, now the applicant  
814 has to wait until the next Planning Board meeting to receive final approval. Ten days before the  
815 meeting is held is when the packet is put together. If they satisfy their precedent conditions of  
816 approval in the time between when the packet goes out and when the meeting is held, the applicant  
817 would have to wait another month.

818  
819 This issue was previously discussed with the Planning Board and it was decided that the actual  
820 information about which projects would be receiving final approval would not be included on the  
821 agenda. However, because projects are not specifically agendaized as receiving final approval, staff  
822 started posting the Board actions on the City website the day after the Planning Board meeting.  
823 Staff is also looking at software products where people who are particularly interested in a project  
824 could sign up for updates on that project and automatically get email notifications or other  
825 notifications throughout the course of the project.

826  
827 **X. Upcoming Dates of Interest**

- 828 • Joint Committee of the Planning Board and PLD – February 12<sup>th</sup>, 6:30 PM
- 829 • Planning Board Steering Committee – February 13<sup>th</sup>, 11:00 AM
- 830 • Planning Board Site Visit – February 21<sup>st</sup>, 8:00 AM – To Be Confirmed
- 831 • Planning Board Meeting – February 26<sup>th</sup>, 6:30 PM

832  
833 There being no further business, Chair Farrington adjourned the meeting at 8:37 PM.

834  
835 Respectfully submitted by,  
836 Krishni Pahl, Minute Taker

837  
838 Reviewed and edited by,  
839 Megan Fortson, Planning Technician



Redefine the possible<sup>sm</sup>

February 12, 2024

To: City of Keene NH  
CC: Evan Clements, City of Keene Planner  
Ref: Markem-Imaje Subdivision for the INF building

To all concerned parties,  
Markem-Imaje is requesting a 6-month extension to the site plan for the subdivision of the Markem-Imaje property located at 150 Congress street Keene NH, 03431.  
The subdivision site plan splitting the INF off to one separate 4-acre lot containing the INF building has been delayed.  
The sale of the building to Commercial Kitchens fell through which has resulted in Markem-Imaje evaluating the current lot plan.

Specifically, Markem-Imaje has run into the following issues delaying our Subdivision:

- We identified fiber optic communications lines running through the tunnel, which needed to be removed as part of the site plan. We have rented pole space from PSNH and have new black fiber single strand installed however, the hookup to the lines has been delayed due to technical issues, resulting in the link not being removed at this time.
- The current plan will also result in the need to change the Markem-Imaje corporate address from 150 congress street to an Optical Ave address. This creates significant constraints for the Company.

As we continue to work towards the link removal and discussions on address change we would like to formally apply/request for the extension so we can provide the best solution for our Neighbors, Community and Markem-Imaje.

Kind regards,  
Shawn Marsh

Site Director Keene NH, Global Director of Quality  
and EHS  
150 Congress Street  
Keene, NH 03431, USA  
603-283-2012  
603-933-0503  
[www.markem-imaje.com](http://www.markem-imaje.com)

Markem-Imaje Industries  
9, rue Gaspard Monge  
26500 Bourg-lès-Valence  
France  
Tel.: +33 (0)4 75 75 55 00  
[www.markem-imaje.com](http://www.markem-imaje.com)

## STAFF REPORT – ADDENDUM

### PB-2024-01 – SURFACE WATER CONDITIONAL USE PERMIT – SURFACE WATER BUFFER REDUCTION – 186 GUNN ROAD

#### **Request:**

Applicants and owners Ashley & Peter Greene request a reduction in the Surface Water Protection buffer from 75' to 30' to allow for the future subdivision and development of the parcel at 186 Gunn Rd (TMP #205-013-000). The parcel is 11 ac and is located in the Rural District.

#### **Background:**

The public hearing for PB-2024-01 was opened at the January 22, 2024 Planning Board meeting. During this meeting, the Planning Board expressed concern about the fact that the Conservation Commission was not able to perform a site visit due to inclement weather prior to this meeting. After discussing the proposed development of the site, potential impacts to wetlands, and the potential of looking into other areas of the parcel that could be subdivided and developed with the Applicant/property owner, the Board members decided to continue the application to their next meeting on February 26, 2024. The reason for this continuation was to provide more time for the Keene Conservation Commission to conduct a site visit and provide a recommendation on this application in accordance with Section 11.6.3, subsection A of the Land Development Code.

Given that the proposed scope of work has not changed, this staff report only outlines the updates that have been provided by the Applicant since the January meeting. More information on this proposal, as well as a more detailed staff report, can be found in the January 22, 2024 Planning Board agenda packet, which is available for review at <https://keeneh.gov/planning-board>.

#### **Determination of Regional Impact:**

After reviewing the application, staff have made a preliminary evaluation that the proposed subdivision does not appear to have the potential for “regional impact” as defined in RSA 36:55. The Board will need to make a final determination as to whether the proposal, if approved, could have the potential for regional impact.

#### **Completeness:**

The Applicant requested exemptions from submitting a landscaping plan, lighting plan, building elevations, drainage, historic evaluation, screening analysis, and an architectural and visual appearance analysis. The Board accepted the application as complete at the January 22, 2024 meeting.

#### **Departmental Comments:**

None

**Application Analysis:** A review of the standards relevant to this application can be found in the staff report that is included in the agenda packet for the January 22, 2024 Planning Board meeting.

#### **Recommended Motion:**

A recommended motion will be provided by staff at the meeting.



City of Keene, NH

# Surface Water Protection Conditional Use Permit (CUP) Application

If you have questions about how to complete this form, please call: (603) 352-5440 or email: [communitydevelopment@keeneh.gov](mailto:communitydevelopment@keeneh.gov)

## SECTION 1: PROJECT INFORMATION

**PROJECT NAME:** Subdivision, Land of Ashley & Peter Greene

**PROJECT ADDRESS(ES):** 186 Gunn Road

## SECTION 2: CONTACT INFORMATION

PROPERTY OWNER	APPLICANT
<b>NAME/COMPANY:</b> Ashley Greene	<b>NAME/COMPANY:</b>
<b>MAILING ADDRESS:</b> 186 Gunn Road	<b>MAILING ADDRESS:</b>
<b>PHONE:</b> 603-903-8547	<b>PHONE:</b>
<b>EMAIL:</b> Ashley.Greene@keene.edu	<b>EMAIL:</b>
<b>SIGNATURE:</b> <i>(SEE PAGE 3)</i>	<b>SIGNATURE:</b>
<b>PRINTED NAME:</b>	<b>PRINTED NAME:</b>

AUTHORIZED AGENT (if different than Owner/Applicant)	FOR OFFICE USE ONLY:	
<b>NAME/COMPANY:</b> Meridian Land Services, Inc.	<b>TAX MAP PARCEL #(s):</b> 205013 - 000 003 000	
<b>MAILING ADDRESS:</b> PO Box 118, Milford, NH 03055		
<b>PHONE:</b> 603-673-1441	<b>PARCEL SIZE:</b> 11 acres	<b>DATE STAMP:</b>
<b>EMAIL:</b> SDIngram@meridianlandservices.com	<b>ZONING DISTRICT:</b> RURAL	
<b>SIGNATURE:</b> <i>Sam Ingram</i>	<b>PROJECT #:</b> PB-2024-01	
<b>PRINTED NAME:</b> Sam Ingram		



## SECTION 3: APPLICATION SUBMISSION REQUIREMENTS

**A COMPLETE APPLICATION MUST INCLUDE THE FOLLOWING ITEMS. BOTH PHYSICAL & DIGITAL COPIES OF APPLICATION MATERIALS MUST BE SUBMITTED USING THE METHODS BELOW.**

- **Digitally:** Email (communitydevelopment@keenenh.gov) or a file-sharing platform (such as Dropbox)
- **Mail / Hand Deliver:** Community Development (4th Floor), City Hall, 3 Washington St, Keene, NH 03431

The submittal requirements for Surface Water Protection Conditional Use Permit (CUP) applications are outlined further in **Article 11.6.3.B** and **Article 25.14** of the [Land Development Code \(LDC\)](#). You may request an exemption from providing any of the items below, except the application fee, notice list, narrative, and mailing labels. The Community Development Director may grant an exemption, if it is determined that the scope of the project does not warrant the submittal.

*Note: Additional information may be required by the respective decision-making authority during the review process.*

### GENERAL SUBMITTAL REQUIREMENTS

**CERTIFIED NOTICE LIST** (See Attachment A for more information.)

**2 SETS OF MAILING LABELS** (See Attachment A for more information.)

**PROJECT NARRATIVE** (See Section 2 of Attachment B for more information.)

**FEES:** Fill in the information below to calculate the total fee.

\$100 base fee + \$62 legal ad fee + (4.98 current USPS certified mailing rate x 10 abutters) = 211.8 (Total Fee)

**NOTE:** Please call the Community Development Department for the current certified mailing rate. Checks should be made payable to the *City of Keene*. Credit card payments are accepted in-person or by calling 603-352-5440.

**INFORMATION DEMONSTRATING THAT THE PROPOSED ENCROACHMENT WILL NOT CAUSE ADVERSE IMPACTS TO THE SURFACE WATER RESOURCE, OR DESIGN DETAILS THAT DEMONSTRATE THAT PROPOSED MITIGATION WILL PREVENT ADVERSE IMPACTS TO THE SURFACE WATER RESOURCE.**

SUBMITTED  
 EXEMPTION REQUESTED

**WAIVERS** (See Section 3 of Attachment B for additional information.)

WAIVER(S) REQUESTED  
 NO WAIVER(S) REQUESTED

PLAN SETS (See Attachment C for additional information.)	SUBMITTED	EXEMPTION REQUESTED
LOCATION MAP OF PROPOSED IMPROVEMENTS	X	
EXISTING CONDITIONS PLAN	X	
PROPOSED CONDITIONS PLAN	X	
GRADING PLAN	X	
LANDSCAPING PLAN		X
LIGHTING PLAN		X
ELEVATIONS		X
TECHNICAL REPORTS (See Attachment C for additional information.)	SUBMITTED	EXEMPTION REQUESTED
DRAINAGE REPORT		X
TRAFFIC ANALYSIS		X
SOIL ANALYSIS		X
HISTORIC EVALUATION		X
SCREENING ANALYSIS		X
ARCHITECTURAL & VISUAL APPEARANCE ANALYSIS		X
OTHER REPORTS / ANALYSES		X

**POSTED NOTICE REQUIREMENT** (See Section 1 of Attachment B for additional information.)



Office: 31 Old Nashua Road, Suite 2, Amherst, NH 03031  
Mailing: PO Box 118, Milford, NH 03055  
Phone: 603-673-1441 \* Fax 603-673-1584  
www.MeridianLandServices.com

December 13, 2023

Keene Planning Board  
3 Washington Street  
Keene, NH 03431

Re: Conditional Use Permit Application, Ashley Greene, Map 205, Lot 13, 186 Gunn Road

Dear Members

Lot 205-13 currently has 1 single family dwelling serviced by an onsite sewage disposal system and well. The lot currently is 11.0 acres and has frontage on Gunn Road. To the east of the dwelling is an existing pole barn utilized for storage. The Owner's intention is to subdivide off one, 2-acre frontage lot east of the pole barn. Due to a poorly drained wetland onsite, this lot is subject to the Surface Water Protection Overlay District. A Conditional Use Permit (CUP) is being sought to reduce the buffer from 75' to 30' to allow for 1 residential dwelling. A Wetland functions and values evaluation has been performed for the wetlands adjacent to the proposed building area and is included within this application.

Pursuant to 20.1.3(A) of the Land Development Code (LDC) single family and two-family dwellings are not required to conform with the site development standards under Article 20.

We respectfully request an exemption from the following plan sets and technical reports.

- Landscaping Plan
- Lighting Plan
- Elevations Plan
- Drainage Report
- Traffic Analysis
- Soil Analysis
- Historic Evaluation
- Screening Analysis
- Architectural & Visual Appearance Analysis
- Other reports /Analysis

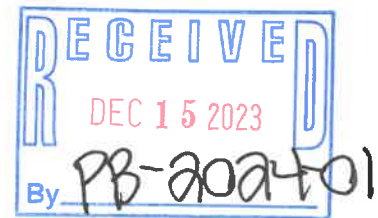

#### 11.6.2 Conditional Use Permit Standards

- A. The proposed use and/or activity cannot be located in a manner to avoid encroachment into the Surface Water Protection Overlay District.

The proposed use and/or activity cannot be located in a manner that avoids encroachment with the lot being subdivided in the eastern corner of the parent lot. The proposed lot meets the necessary frontage and acreage for a single-family lot in the rural zone. No direct wetland impacts are proposed. Best

NARRATIVE



management practices are to be implemented before, during and until the disturbance areas have been stabilized per the erosion control notes.

- B. Encroachment into the buffer area has been minimized to the maximum extent possible, including reasonable modification of the scale or design of the proposed use.

This application includes a sewage disposal plan for a 4 bedroom 32'x26' dwelling. The design depicts that the septic system, well and dwelling can be constructed without encroaching within 30' of the wetlands. The house and well fit outside of the proposed 30' buffer. The grading associated with the house and leachfield do not encroach closer than 30' to the wetland edge. The leachfield and tank maintain the State required 50-foot separation from wetlands. Driveway and associated grading are located within 30' of wetlands however do not directly impact wetlands.

- C. The nature, design, siting, and scale of the proposed use and the characteristics of the site, including but not limited to topography, soils, vegetation, and habitat, are such that when taken as a whole, will avoid the potential for adverse impacts to the surface water resource.

The site is designed to have no structures within 30' of the wetland edge to prevent adverse impacts to the wetlands. Infiltration trenches are proposed to capture stormwater runoff from the dwelling. Spruce trees are to be planted along the edge of the proposed grading to aid in soil stability and buffer identification. Leachfield and tank maintain at least 50' to the wetland edge and meet all NHDES subsurface design regulations.

- D. The surface water buffer area shall be left in a natural state to the maximum extent possible. The Planning Board may establish conditions of approval regarding the preservation of the buffer, including the extent to which trees, saplings and ground cover shall be preserved.

The surface water buffer will remain in a natural state except for the driveway and associated grading. The proposed reduced buffer area around the house site is not proposed to be impacted. Silt fence is to be installed and maintained per the erosion control notes. This fencing will remain in place until the completion of the site construction. Silt Fencing will also act as a barrier to contain not only silt but workers onsite. Once finish grading is complete, spruce trees are to be planted along the edge of the finish grading. These plantings are to act as a natural barrier along the buffer and soil stabilization.

- E. The Planning Board may consider the following to determine whether allowing the proposed encroachment will result in an adverse impact on the surface water resource.
  - 1. The size, character, and quality of the surface water and the surface water buffer being encroached upon.

The wetlands are palustrine, forested, saturated and are not to be directly impacted. A wetland evaluation was completed using the Highway Methodology



and found that the wetlands adjacent to the building area have no suitable wetland functions or values of significant importance (see report).

2. The location and connectivity of the surface water in relation to other surface waters in the surrounding watershed.

The wetland complex drains to a stream over 400' down slope. By following the erosion control notes listed on the plan the stream will not be impacted by this project.

3. The nature of the ecological and hydrological functions served by the surface water.

Based on the Wetland evaluation the associated wetland area is of low value. Vegetation density is low therefore this application proposes planting along the grading to aid in soil stability and buffer identification.

4. The nature of the topography, slopes, soils, and vegetation in the surface water buffer.

The average slope within the buffer is 10 to 15 percent with the maximum slope to the rear of the proposed dwelling to be 22 percent. Siltation control is to be properly installed and maintained per the erosion control notes. Test pit observations onsite determined that the soils are fine sandy loam to sandy loam. Vegetation is low density and comprises of mainly Hemlock, Ash, and Maple with little ground cover. This application proposes plantings along the edge of finish grading to aid in buffer identification and soil stability.

5. The role of the surface water buffer in mitigating soil erosion, sediment and nutrient transport, groundwater recharge, flood storage, and flow dispersion.

Results from the wetland evaluation found that the wetland serves little function in sediment and nutrient transport, groundwater recharge, flood storage, and flow dispersion. The current wetland buffer has relatively low vegetation density. This application intends to propose plantings along the proposed 30' buffer to aid in soil stability and buffer protection.

6. The extent to which the surface water buffer serves as wildlife habitat or travel corridor.

This wetland is not located within high value wildlife habitat based upon the wildlife action plan. Gunn Road is located adjacent to the wetland and currently acts as barrier to faunal migration. Except for the transmission lines, natural woodlands extend at least a ½ mile behind the site and act an effective travel corridor.



# MERIDIAN LAND SERVICES, INC.

CIVIL ENGINEERING | LAND SURVEYING | PERMITTING | SOIL & WETLAND MAPPING | SEPTIC DESIGN | ENVIRONMENTAL

Office: 31 Old Nashua Road, Suite 2, Amherst, NH 03031

Mailing: PO Box 118, Milford, NH 03055

Phone: 603-673-1441 \* Fax 603-673-1584

www.MeridianLandServices.com

7. The rate, timing and volume of stormwater runoff and its potential to influence water quality associated with the affected surface water or any associated downstream surface waters.

To mitigate stormwater runoff, infiltration trenches are proposed along the proposed dwelling. With that being said the wetlands eventually drain to a stream greater than 400' down slope. Due to the distance between the site and stream and the site design there will be no negative affects to the stream down slope.

8. The sensitivity of the surface water and the surface water buffer to disruption from changes in the grade or plant and animal habitat in the buffer zone.

To minimize disruptions to the surface water and its associated buffer, siltation control is proposed and is to remain until the soils have been stabilized with a healthy growth of vegetation. Plantings along the buffer are to aid in soil stability and define the edge of the proposed buffer. Infiltration trenches are to aid in stormwater infiltration from the proposed dwelling. The area to the rear of the lot is to remain unaltered to allow for animal and plant habitat.

Thank you for your consideration.

Very truly yours,  
**Meridian Land Services, Inc.**

Jason C. Bolduc, CWS/CSS  
Project Manager

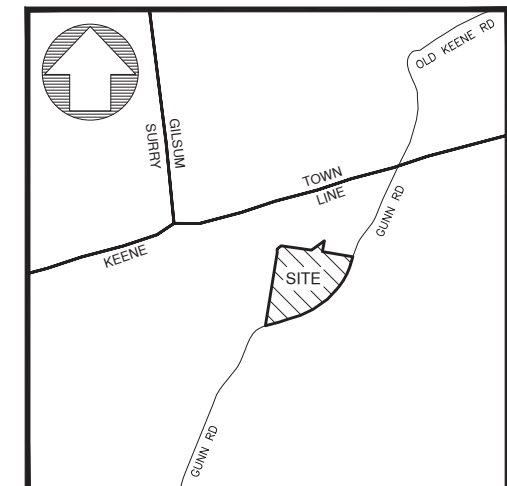

**LOCUS MAP:**  
SCALE: 1"=1,000'±

**REFERENCE PLAN:**  
"LOT LINE ADJUSTMENT - PREPARED FOR - ROBERT PHILLIPSON JR. - & ELAINE LEDWITH - GUNN ROAD - CITY OF KEENE - COUNTY OF CHESHIRE - STATE OF NEW HAMPSHIRE", SCALE: 1"=100', DATED: APRIL 8 2014, PREPARED BY: PDAVID A. MANN, RECORDED C.C.R.D. PLAN #14099.

- NOTES:**
1. THE PURPOSE OF THIS PLAN IS TO DEPICT A TWO LOT SUBDIVISION CONCEPT OF TAX MAP 205 LOT 13. LOTS WILL BE SERVICED BY ON SITE SEWAGE DISPOSAL SYSTEMS AND ON SITE PRIVATE WELLS.
  2. THE OWNER OF RECORD IS ASHLEY GREENE. SEE C.C.R.D. BOOK 3114 PAGE 467.
  3. THE EXISTING AREA OF LOT 205-13 IS 11± ACRES (PRE-SUBDIVISION).
  4. WETLANDS WERE DELINEATED ON THE ENTIRETY OF LOT 205-13. HOWEVER ONLY THE WETLANDS IN THE NORTHEAST CORNER OF THE LOT WERE LOCATED. ADDITIONAL BUILDING RESTRICTIONS ON REMAINING LOT 205-13 APPLY THAT ARE NOT SHOWN OR NOTED HEREON.
  5. WETLANDS WERE DELINEATED IN ACCORDANCE WITH THE "CORPS OF ENGINEERS WETLANDS DELINEATION MANUAL" (1987) AND THE REGIONAL SUPPLEMENT BY JASON C. BOLDOC, CWS, AUGUST 2023.

- LEGEND:**
- RIGHT-OF-WAY SIDELINE
  - PROPERTY LINE
  - ABUTTING LOT LINE
  - EASEMENT LINE
  - BUILDING SETBACK LINE
  - EDGE OF PAVEMENT
  - EXISTING GRAVEL ROAD
  - OH EXISTING OH ELECTRIC LINE
  - EDGE OF WETLANDS
  - STONE WALL
  - 10' CONTOUR INTERVAL
  - 2' CONTOUR INTERVAL
  - 205-13 EXISTING TAX MAP AND LOT NUMBER
  - EXISTING BUILDING
  - POTENTIAL 4,000 S.F. SEPTIC AREA
  - EXISTING TREE LINE
  - EXISTING GRANITE BOUND FOUND
  - EXISTING DRILL HOLE FOUND/SET
  - EXISTING IRON PIPE FOUND
  - EXISTING UTILITY POLE & GUY WIRE
  - EXISTING WELL

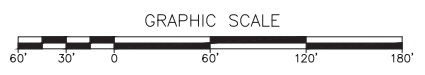

REV.	DATE	DESCRIPTION	C/O	DR	CK
D	--	--	--	--	--
C	--	--	--	--	--
B	--	--	--	--	--
A	--	--	--	--	--

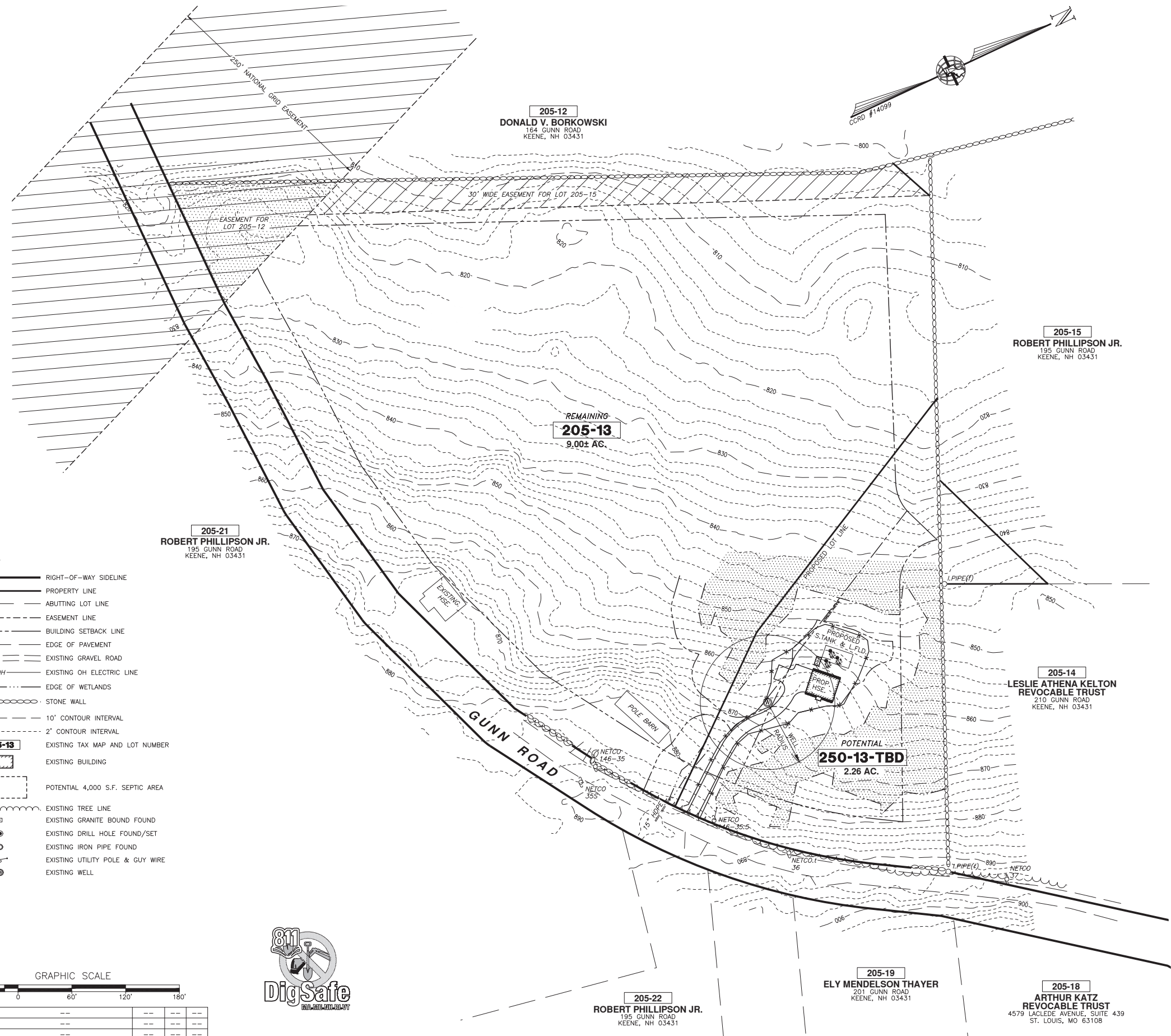

**SURFACE WATER PROTECTION CONDITIONAL USE PERMIT EXHIBIT**  
**PREPARED FOR:**  
**ASHLEY & PETER GREENE**  
 TAX MAP 205 LOT 13  
 186 GUNN ROAD  
 KEENE, NEW HAMPSHIRE  
 SCALE: 1" = 60'      DECEMBER 14, 2023



**MERIDIAN**  
**LAND SERVICES, INC.**  
 ENGINEERING | SURVEYING | PERMITTING  
 SOIL & WETLAND MAPPING | SEPTIC DESIGN  
 31 OLD NASHUA ROAD, AMHERST, NH 03031 TEL. 603-673-1441  
 MERIDIANLANDSERVICES.COM FAX 603-673-1584

Plotfile: 12/14/2023 11:04 AM By: JCB  
 H:\MIS\12274\12274.00\DRAWINGS\SURV\12274CUP PG 1.dwg

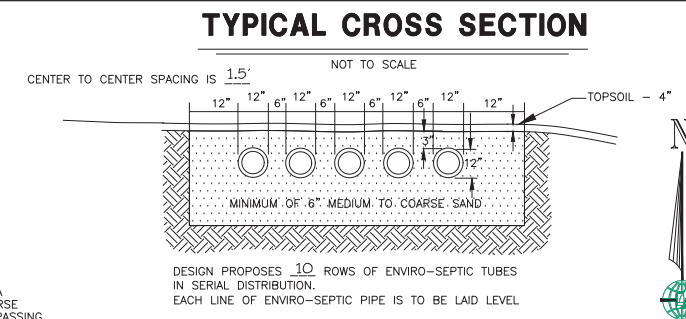
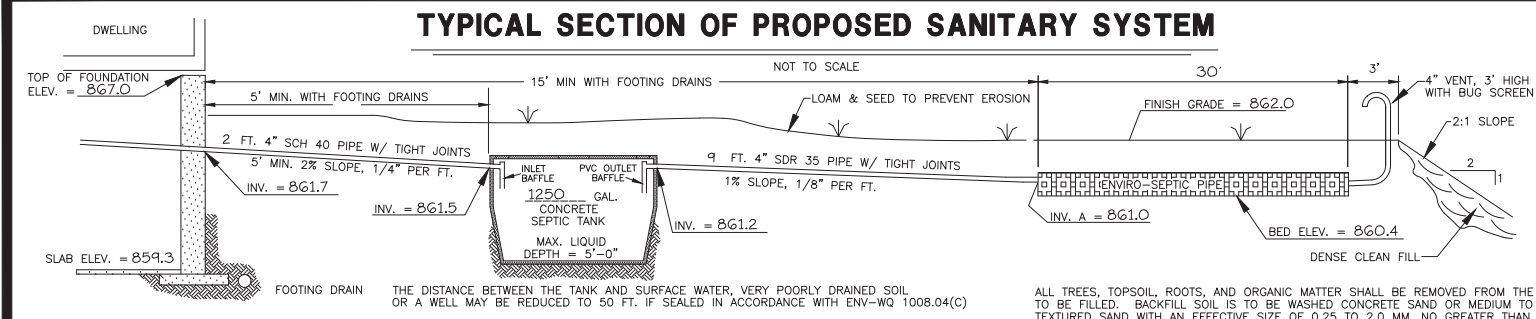

### TEST PIT DATA

NOT TO SCALE

TP 1	10/13/23	TP 2	10/13/23
10YR 3/2 VERY DARK GRAYISH BROWN LOAM	6'	10YR 3/2 VERY DARK GRAYISH BROWN LOAM	3'
10YR 4/4 DARK YELLOWISH BROWN FINE SANDY LOAM GRANULAR VERY FRIABLE	13'	10YR 4/4 DARK YELLOWISH BROWN FINE SANDY LOAM GRANULAR VERY FRIABLE	16'
2.5Y 5/6 LIGHT OLIVE BROWN GRAVELLY SANDY LOAM SUBANGULAR BLOCKY VERY FRIABLE	30'	2.5Y 5/6 LIGHT OLIVE BROWN GRAVELLY SANDY LOAM SUBANGULAR BLOCKY VERY FRIABLE	22'
2.5Y 6/4 LIGHT YELLOWISH BROWN STONY SANDY LOAM MASSIVE FRIABLE	49'	2.5Y 6/4 LIGHT YELLOWISH BROWN STONY SANDY LOAM MASSIVE FRIABLE	29'
ROOTS	15'	ROOTS	16'
LEDGE	49'	LEDGE	29'
WATER	NONE	WATER	NONE
S.H.W.T.	27'	S.H.W.T.	22'
HARDPAN	NONE	HARDPAN	NONE
PERC. TEST 10 MIN./IN. AT 26"		PERC. TEST ____ MIN./IN. AT ____"	
DATE 10/13/23		DATE	

#### EROSION CONTROL NOTES:

- INSTALLATION OF SILTATION FENCES SHALL BE COMPLETED PRIOR TO THE START OF SITE WORK IN ANY GIVEN AREA. PREFABRICATED SILTATION FENCES SHALL BE INSTALLED ACCORDING TO THE MANUFACTURER'S RECOMMENDATIONS.
- STRAWBALE BARRIERS AND SILTATION FENCES SHALL BE KEPT CLEAN DURING CONSTRUCTION AND REMOVED WHEN ALL SLOPES HAVE A HEALTHY STAND OF VEGETATIVE COVER. EROSION CONTROL MEASURES SHALL BE INSPECTED ON A WEEKLY BASIS AND AFTER EVERY RAINFALL.
- EXISTING VEGETATION IS TO REMAIN UNDISTURBED WHEREVER POSSIBLE.
- THE AREA OF LAND EXPOSED AND THE TIME OF EXPOSURE SHALL BE MINIMIZED. ALL DISTURBED AREAS SHALL BE STABILIZED WITHIN 72 HOURS AFTER FINAL GRADING.
- ALL DISTURBED AREAS SHALL HAVE A MINIMUM OF 4.5" OF LOAM INSTALLED WITH SOD OR NOT LESS THAN 1.1 POUNDS OF SEED MIX PER 1,000 SQ. FT. SEED MIXTURE SHALL BE:
  - TALL FESCUE - 0.45 LBS.
  - CREeping RED FESCUE - 0.45 LBS.
  - BIRDFOOT TREFOIL - 0.20 LBS.
- NO FERTILIZER SHALL BE APPLIED TO VEGETATION OR SOILS LOCATED WITHIN 25 FEET OF THE REFERENCE LINE.
- LIME AND LOW PHOSPHATE SLOW RELEASE FERTILIZER SHALL BE INCORPORATED INTO THE SOIL PRIOR TO OR AT THE TIME OF SEEDING. SEEDING PRACTICES SHALL COMPLY WITH LOCAL USDA NATURAL RESOURCE CONSERVATION SERVICES RECOMMENDATIONS. LOW PHOSPHATE, SLOW RELEASE NITROGEN FERTILIZER TO CONTAIN NO MORE THAN 2% PHOSPHOROUS AND AT MINIMUM 50% SLOW RELEASE NITROGEN COMPONENTS
- PERMANENT OR TEMPORARY COVER MUST BE IN PLACE BEFORE THE GROWING SEASON ENDS. WHEN SEEDING AREAS ARE MULCHED, PLANTINGS MAY BE MADE FROM EARLY SPRING TO EARLY OCTOBER. WHEN SEEDING AREAS ARE NOT MULCHED, PLANTINGS SHOULD BE MADE FROM EARLY SPRING TO MAY 20 OR FROM AUGUST 15 TO SEPTEMBER 15. NO DISTURBED AREA SHALL BE LEFT EXPOSED DURING WINTER MONTHS.

#### CONSTRUCTION SEQUENCE NOTES:

- INSTALL SILTATION CONTROL FENCES IN LOCATIONS SHOWN ON PLANS. EROSION AND SEDIMENTATION CONTROL MEASURES SHALL BE INSTALLED PRIOR TO ANY EARTH MOVING OPERATION.
- CUT AND CLEAR TREES; DISPOSE OF DEBRIS.
- ROUGH GRADE SITE AND CONSTRUCT DRIVE. ALL CUT AND FILL SLOPES SHALL BE STABILIZED UPON COMPLETION OF ROUGH GRADING PER THE EROSION CONTROL NOTES.
- CONSTRUCT DWELLING, SEPTIC SYSTEM AND WELL.
- INSPECT AND MAINTAIN EROSION CONTROL MEASURES ON A DAILY BASIS AND AFTER ANY STORMS.
- DAILY, OR AS REQUIRED, CONSTRUCT TEMPORARY BERMS, CULVERTS, DITCHES, SILTATION FENCES, SEDIMENT TRAPS, ETC. MULCH AND SEED AS REQUIRED.
- FINISH GRADING TO PREPARE FOR PAVING, LOAMING AND SEEDING. RED SPRUCES ARE TO BE PLANTED ALONG THE WETLAND BUFFER AS DEPICTED. ALL DISTURBED AREAS SHALL BE STABILIZED WITHIN 72 HOURS AFTER FINAL GRADING.
- TEMPORARY EROSION CONTROL MEASURES SHALL BE REMOVED WHEN ALL DISTURBED AREAS HAVE BEEN STABILIZED WITH A HEALTHY GROWTH OF VEGETATION.

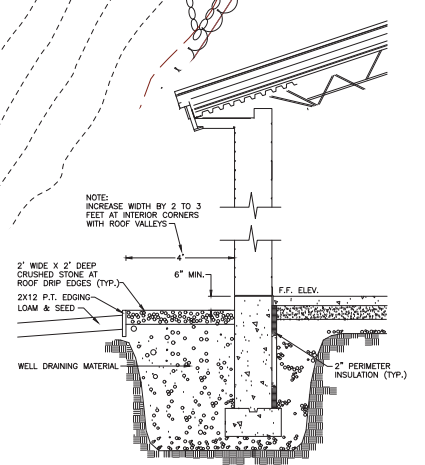
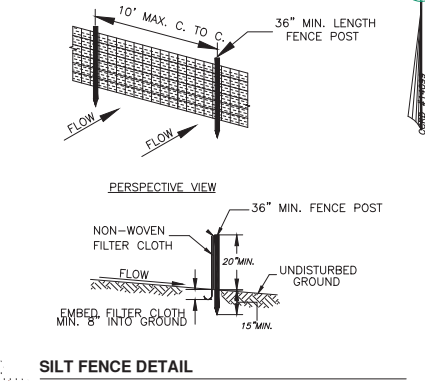
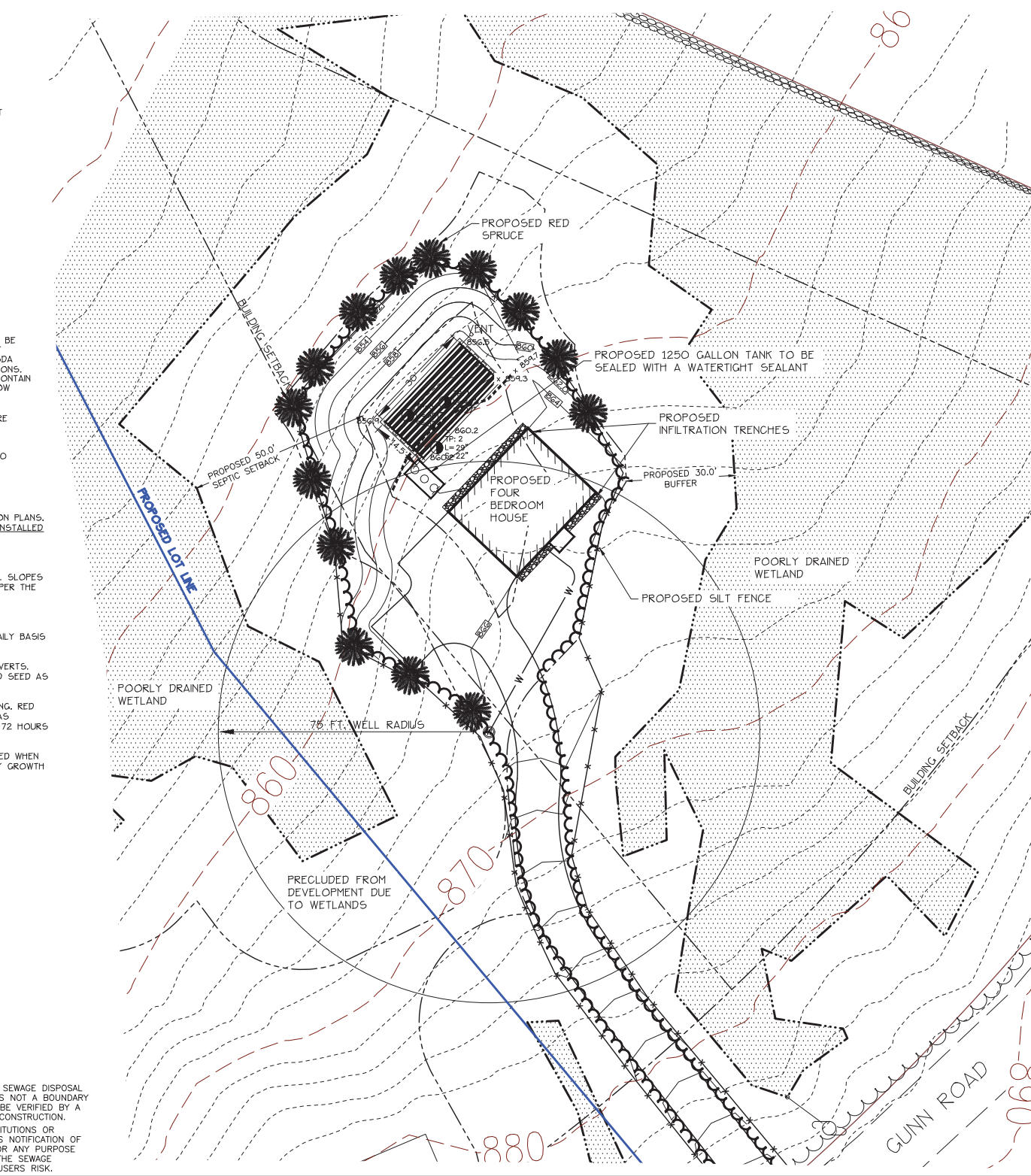
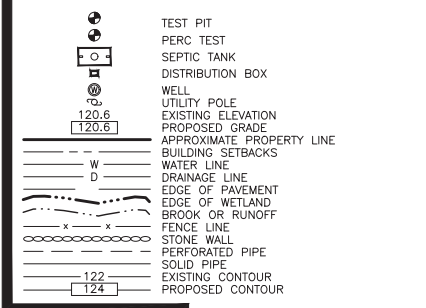

SOIL DATA:	79C: PERU FINE SANDY LOAM, 8 TO 15% SLOPES, VERY STONY
DESIGN DATA:	4 BEDROOMS AT 10 MIN. IN. REQUIRES 280 LIN FT.
PROPOSED ARE	10 ROWS OF 30 LIN. FT. EACH OR 300 LIN FT. TOTAL
DESIGN INTENT:	DUE TO SHWT AT 22" THE BOTTOM OF THE EFFLUENT DISPOSAL SYSTEM (EDS) SHALL BE CONSTRUCTED AT 860.4 ELEVATION. THIS IS APPROXIMATELY 0.2' ABOVE ORIGINAL GROUND ON THE HIGH CONTOUR OF THE EFFLUENT DISPOSAL SYSTEM (EDS).
LEACHFIELD IS TO BE	REBUILT IN PLACE IF REPLACEMENT BECOMES NECESSARY.
WETLANDS HAVE BEEN	DELINEATED IN ACCORDANCE WITH ENV-WQ 1014.06 BY JASON C. BOLDUC.
50% OR MORE OF THE	LEACHFIELD IS BEYOND ELEV. 859.7 AND WILL MAINTAIN 2.5 FT. OR GREATER TO THE SEASONAL HIGH WATER TABLE
THERE ARE NO POORLY	DRAINED WETLANDS WITHIN 50 FT. OF THE LEACHFIELD
THERE ARE NO VERY	POORLY DRAINED WETLANDS WITHIN 75 FT. OF THE LEACHFIELD

PLANTINGS

SYMBOL	COMMON NAME	SCIENTIFIC NAME	NUMBER	SIZE
	RED SPRUCE	PICEA RUBENS	14	3'-4'

TREES TO BE PLANTED AT LEAST 10 FEET APART.

POTENTIAL SEWAGE DISPOSAL SYSTEM EXHIBIT

## LOT 205-13-TBD

### KEENE, NEW HAMPSHIRE

SCALE: 1"=20'

DECEMBER 14, 2023

OWNER: ASHLEY GREENE

186 GUNN ROAD, KEENE, NH 03431

REV.	DATE	DESCRIPTION	INIT.

**MERIDIAN**  
LAND SERVICES, INC.

ENGINEERING | SURVEYING | PERMITTING  
SOIL & WETLAND MAPPING | SEPTIC DESIGN

31 OLD NASHUA ROAD, AMHERST, NH 03801 TEL: 603-675-1441  
MERIDIAN.LANDSERVICES.COM FAX: 603-675-1584

ENVIRO-SEPTIC WASTEWATER TREATMENT SYSTEMS ARE APPROVED BY NHDES AS ITA IN ACCORDANCE WITH PART ENV-Wq 1024. THE SYSTEM IS DESIGNED IN ACCORDANCE WITH THE ENVIRO-SEPTIC AND SIMPLE SEPTIC LEACHING SYSTEM DESIGN AND INSTALLATION MANUAL AND THE ENVIRO-SEPTIC WASTEWATER TREATMENT SYSTEM DESIGN AND INSTALLATION MANUAL NEW HAMPSHIRE STATE ATTACHMENT.

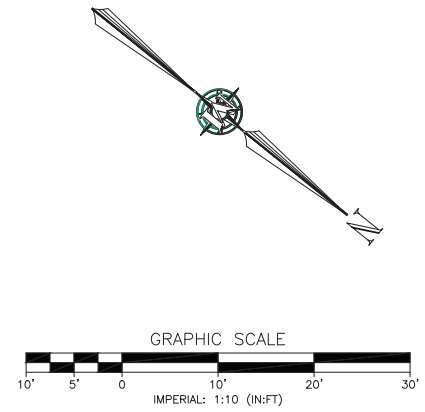
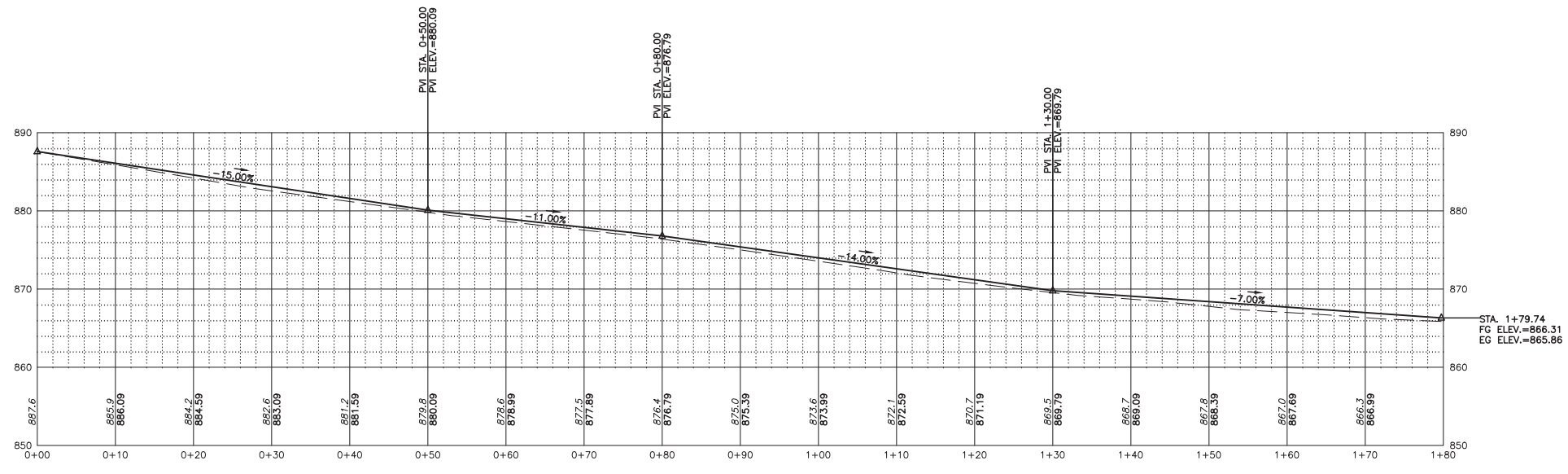
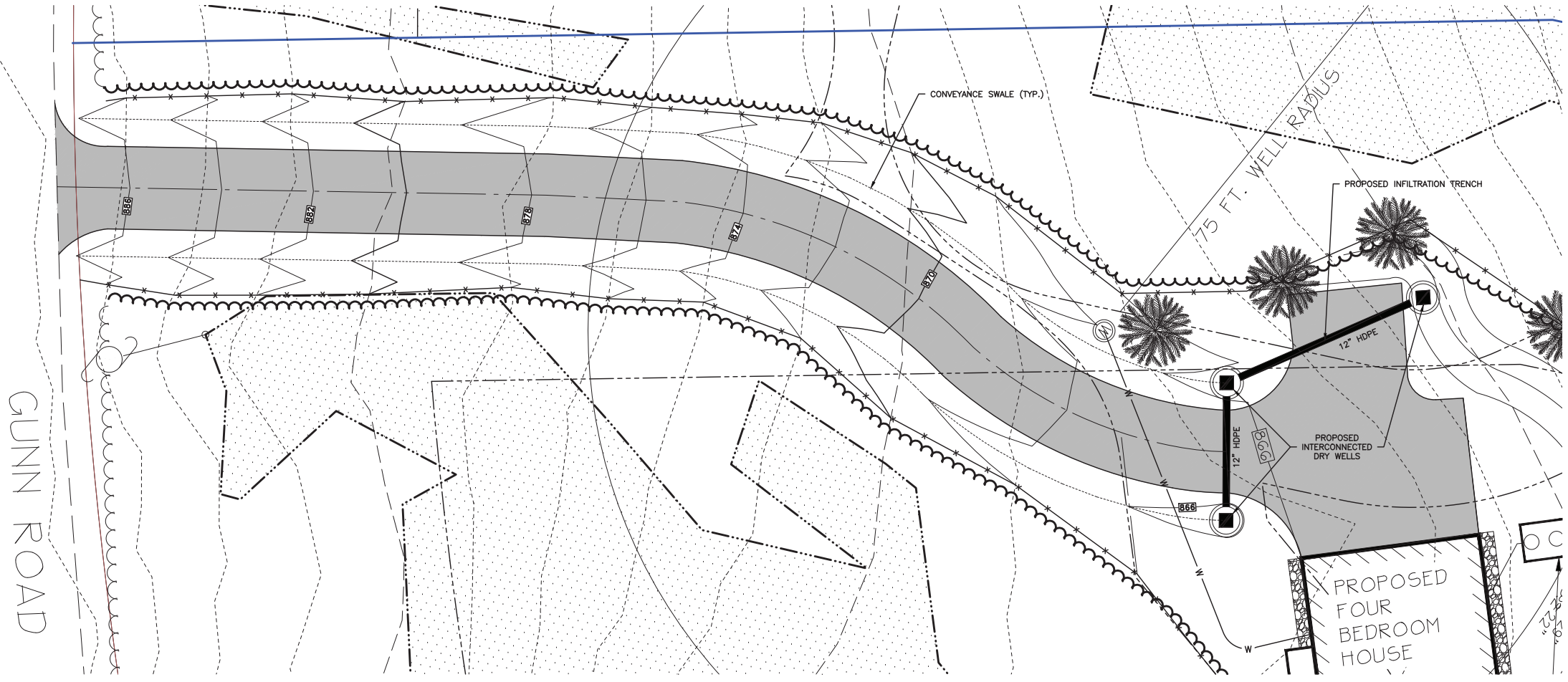

REV.	DATE	DESCRIPTION	DR	CK
I				
H				
G				
F				
E				
D				
C				
B				
A				

DRIVEWAY PLAN AND PROFILE

ASHLEY GREENE  
186 GUNN ROAD  
MAP 205 LOT 13-TBD  
KEENE, NEW HAMPSHIRE

P-1  
SHEET

PROJECT 12274.P00  
NO. 1 OF 2

32 OF 40







## STAFF REPORT

### SPR-01-13, MODIFICATION #3 – SITE PLAN – CHESHIRE COUNTY SHOOTING SPORTS EDUCATION FOUNDATION, 19 FERRY BROOK RD

#### **Request:**

Applicant SVE Associates, on behalf of owner the Cheshire County Shooting Sports Education Foundation, proposes several site modifications, including the relocation of the previously approved stormwater management system, on the property at 19 Ferry Brook Rd (TMP #214-021-000). The parcel is 55 ac and is located in the Rural District.

#### **Background:**

The subject parcel is an existing 55-acre lot located between the intersection of Ferry Brook Rd to the west and Sullivan Rd to the east and shares a northern property boundary with the town of Sullivan. Residential properties and undeveloped lots abut this parcel in all directions. The property is the site of the Cheshire County Shooting Sports Education Foundation (CCSSEF) and includes several different features on the lot related to the operation of the club, including outdoor and indoor shooting ranges and a clubhouse.

This parcel has undergone site plan review previously, including an initial Major Site Plan application, SPR-01-13, that was submitted to the Planning Board for review in 2013 for the expansion of their recreational operation to include an ~26,000-sf indoor shooting range. This application was conditionally approved in February 2014, but subsequently amended as part of another Site Plan application, SPR-01-13 Modification #1, which expired prior to the commencement of any work. An updated Site Plan application, SPR-01-13 Modification #2, was conditionally approved by the Board in August 2020 for the construction of an ~3,300-sf indoor shooting range and the construction was subsequently completed.

During site visits from January-November 2022, City Staff noted that there were several deviations from the most recently approved site plan. These changes included the addition of a trailer to the rear of the club house/indoor shooting range that was serving as classroom space, the improper installation of the stormwater management system, and a change to the approved exterior finish materials for the clubhouse and indoor shooting range. Staff also noted that there was a large, engineered gravel/sand berm to the northwest of the clubhouse that was being used as an unapproved outdoor shooting range and was within close proximity of the surface water buffer.

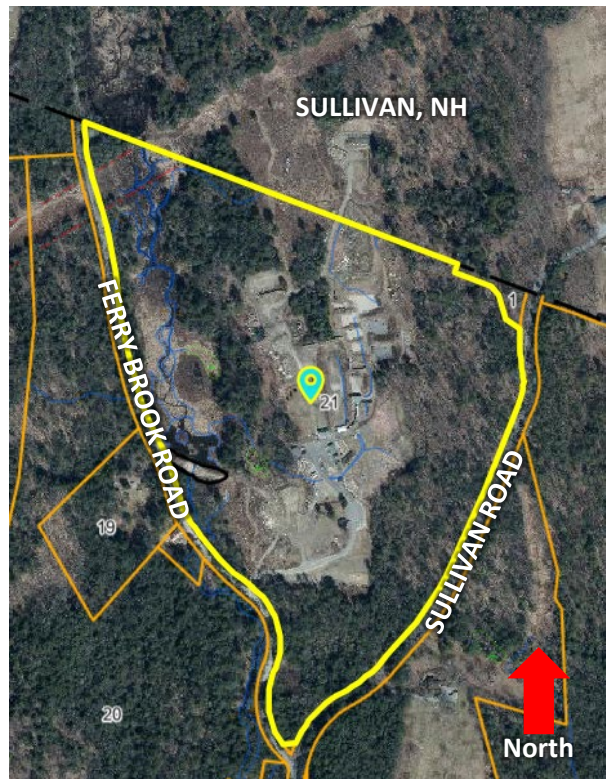

*Figure 1. Aerial imagery of the CCSSEF site at 19 Ferry Brook Rd from 2020.*

## STAFF REPORT

In December 2022, Planning Staff started the enforcement process with the CCSSEF due to a lack of response regarding the above-mentioned site plan compliance issues. This application is being submitted to seek approval for the changes to their approved site plan, to include the gravel berm on the existing and proposed conditions plans, for the installation of a new stormwater management system, to address the changes to the exterior finish materials for the clubhouse/indoor shooting range, and to include the trailer that is utilized as classroom space on the proposed site plan.

### **Determination of Regional Impact:**

After reviewing the application, staff have made a preliminary evaluation that the proposed site plan does not appear to have the potential for “regional impact” as defined in RSA 36:55. The Board will need to make a final determination as to whether the proposal, if approved, could have the potential for regional impact.

### **Completeness:**

The Applicant has requested exemptions from submitting a landscaping plan, lighting plan, elevations, a traffic analysis, soil analysis, historic evaluation, screening analysis, and architectural & visual appearance analysis. After reviewing each request, staff recommend that the Board grant the requested exemptions and accept the application as “complete.”

### **Departmental Comments:**

- **Code Enforcement:** A building permit will be required prior to the installation of the 10’ tall stockade fence adjacent to the trailer.

**Application Analysis:** The following is a review of the Planning Board development standards relevant to this application.

**20.2 Drainage:** In the narrative and plans for this project, the Applicant states that the stormwater level spreader will be relocated from the top of the slope to the west of the clubhouse/indoor shooting range to the bottom of the slope closer to the engineered berms. The narrative states that stormwater will sheet flow to the proposed level spreader at the bottom of the slope. The Board may want to consider making the submittal of a letter stamped by a Professional Engineer licensed in the State of NH confirming that the level spreader has been installed and is functioning properly a subsequent condition of approval. Figure 1 shows the area where the level spreader was originally supposed to be installed as part of SPR-01-13, Modification #2.

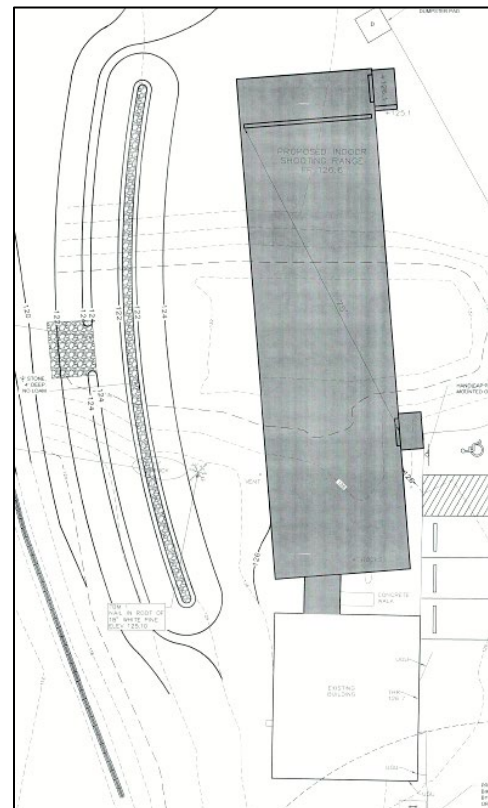

*Figure 2. Snippet of the approved site plan from SPR-01-13, Mod. 2 showing the original approved location of the level spreader to the immediate west of the clubhouse and indoor shooting range.*

# STAFF REPORT



*Figures 3 & 4. Photos of the engineered berm taken during a staff visit to the site in November 2022.*

**20.3 Sediment & Erosion Control:** The narrative for this project states that the engineered berm on the western portion of the property was constructed using surplus materials from the site and has historically been used by the CCSSEF as an overflow shooting range and space for approximately six public events per year. In the narrative, the Applicant goes on to say that they would like to continue using the berm for the same purpose moving forward and plan on seeding/mulching the berm to stabilize it. The narrative also states that the



*Figures 5-7 (from left to right). Aerial imagery from 2010, 2015, and 2020 showing the evolution of the southwestern portion of the site where the berm is now located.*

## STAFF REPORT

landowner will monitor and repair the erosion control measures on a regular basis into the future. A note to this effect has been added to the site plan on Sheet C-1 of the plan set.

The site plan also shows a topsoil pile, boulder pile, and portion of the berm within the 75' surface water buffer. The Applicant proposes to remove these encroachments from the buffer area. The Board may want to consider including a subsequent condition of approval requiring that the surface water buffer be flagged by a soil scientist licensed in the State of NH and the site inspected by the Community Development Director, or their designee, following the removal of these materials from the surface water buffer. Additionally, the Board may also want to consider adding a precedent condition of approval requiring the submittal of a security to cover the cost of sediment and erosion control while the new stormwater management system is being installed.

Figures 3-7 show photos of the engineered berm that were taken during a 2022 staff site visit, as well as aerial imagery from recent years documenting the changes made to the portion of the site where the berm is now located.

- 20.4 Snow Storage & Removal:** The narrative states that snow will be stored on site. This standard appears to be met.
- 20.5 Landscaping:** The narrative states that there are no changes proposed to landscaping as part of this application. This standard is not applicable.
- 20.6 Screening:** The narrative and plan indicate that a 10'-tall stockade fence is going to be installed along the west and south sides of the trailer used as a classroom to obscure it from view of vehicles entering the site along the driveway to the south. This trailer will not be visible from any public right-of-way, so this standard appears to be met.
- 20.7 Lighting:** The narrative states that there are no changes proposed to any lighting on the site. This standard is not applicable.
- 20.8 Sewer & Water:** The site is served by on-site well and septic. No changes to these systems are proposed with this application. This standard is not applicable.
- 20.9 Traffic & Access Management:** The bike rack that was shown near the southeastern corner of the clubhouse building on the previous site plan for SPR-01-13, Modification #2 was never installed. This bike rack is shown in the same location on the updated site plan. The Board may want to considering making documentation showing that the bike rack was installed in the appropriate location a subsequent condition of approval.
- 20.10 Filling & Excavation:** The narrative states that there will be fill added to the site for the emergency spillway that will be located to the southwest of the proposed level spreader. Construction vehicles entering the property could access the site using Route 9, which is the closest highway to the south. The Board may wish to ask the Applicant to clarify how much fill is proposed to be added to the site and if a construction vehicle plan is necessary. The Board will need to determine if this standard has been met.

# STAFF REPORT

**20.11 Surface Waters & Wetlands:** As mentioned previously, the proposed conditions plan shows sections of the topsoil and boulder piles and engineered berm that are located within the 75' wetlands buffer, but which are proposed to be removed. The proposed plan also shows the temporary encroachment of silt fencing that will be installed around the gravel berm into the surface water buffer while the berm is being stabilized with vegetation. The Board may want to consider adding the recommended subsequent condition of approval related to a site inspection of the surface water buffer following the removal of materials from this area. If these materials are not removed from the surface water buffer, the property owner would need to come back to the Board to seek approval for a Surface Water Conditional Use Permit (CUP) for any potential impacts that the storage of these materials may have on the buffer. The Board will need to determine if this standard has been met.

**20.12 Hazardous & Toxic Materials:** In their narrative, the Applicant states that there will not be any hazardous or toxic materials stored onsite. This standard appears to be met.

**20.13 Noise:** In their narrative, the Applicant states that there is no change proposed to the level of noise currently generated by activities on the site. This standard appears to be met.

**20.14 Architecture & Visual Appearance:** As part of this application, the property owner is looking to document the addition of the trailer used as classroom space on the site and is proposing to screen the trailer from view of traffic entering the property along the drive aisle to the south using a 10'-tall stockade fence. It should be noted that the trailer is shown on the existing conditions plan that was submitted, but that it was installed without the knowledge of City Staff following the approval of the most recent site plan application.

In addition to this, the Applicant is seeking approval for a change that was made to the exterior finish materials following the Board's approval of the indoor shooting range. Figure 8 shows a snippet of the elevations approved by the Board as part of SPR-01-13 Mod. 2, which show a red concrete masonry unit (CMU) finish for the addition. Figures 9-11 show photos taken by staff during a site visit showing the tan vinyl siding that was installed, as

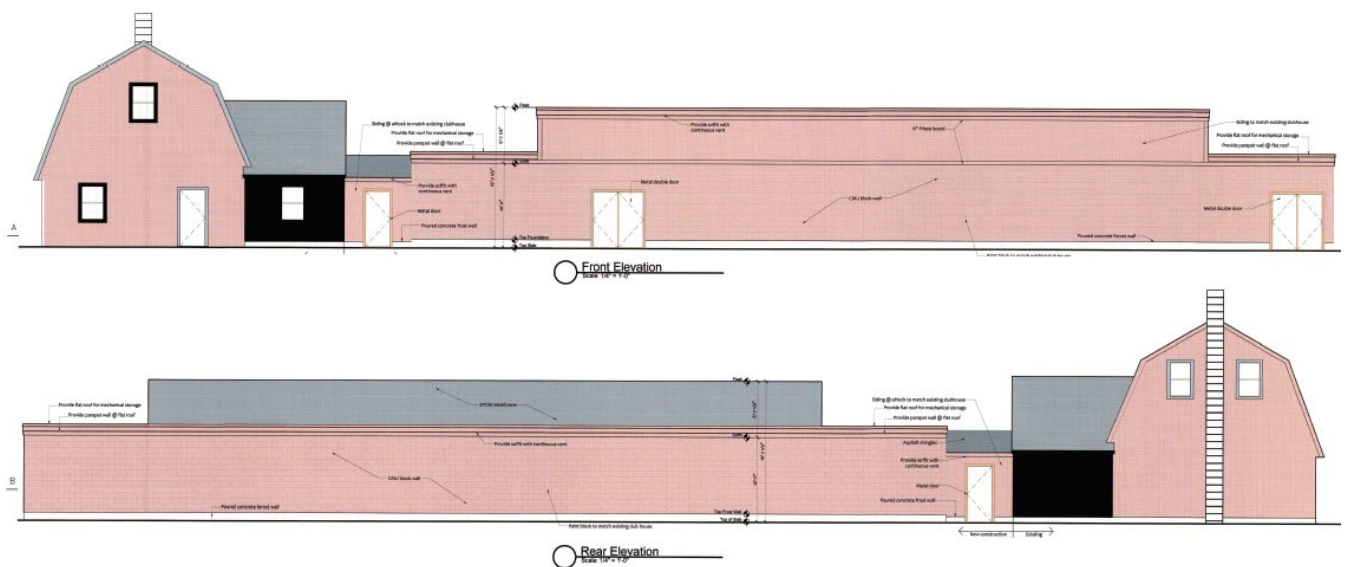

Figure 8. Snippet of approved elevations from SPR-01-13, Mod. 2

## STAFF REPORT

well as a photo of the trailer that was added to the rear of the clubhouse. The Board will need to determine if this standard has been met.



*Figures 9-11 (from left to right). Photos taken during a November 2022 site visit showing the exterior of the clubhouse and indoor shooting range and the location of the trailer used as classroom space to the rear of the clubhouse.*

### **Recommended Motion:**

If the Board is inclined to approve this request, the following motion is recommended:

**“Approve SPR-01-13, Mod. 3, as shown on the plan set identified as “Cheshire County Shooting Sports Education Foundation, 19 Ferry Brook Rd, Keene, New Hampshire” prepared by SVE Associates at a scale of 1 inch = 20 feet on January 15, 2024 and last revised on February 9, 2024, with the following conditions:**

- 1. Prior to final approval and signature by the Planning Board Chair, the following conditions precedent shall be met:**
  - a. Owner’s signature appears on the title page and Sheet C-1 of the plan set.**
  - b. Submittal of a security for sediment and erosion control in a form and amount acceptable to the Community Development Director and City Engineer.**
  - c. Submittal of five full-size paper copies and a digital PDF copy of the final plan set.**
- 2. Subsequent to final approval and signature by the Planning Board Chair, the following conditions subsequent shall be met:**

## STAFF REPORT

- a. **Prior to the commencement of site work, the Community Development Department shall be notified when all erosion control measures are installed and the Community Development Director, or their designee, shall inspect the erosion control measures to ensure compliance with this site plan and all City of Keene regulations.**
- b. **Within three months of the date of final approval for this application, the bike rack will be placed in the approved location and a photo will be sent to Community Development save in the project folder to document the installation.**
- c. **Within six months of the date of final approval for this application, the topsoil, boulder piles, and portion of the berm within the 75' surface water will be removed. The buffer will then be flagged by a soil scientist licensed in the State of NH and subject to an inspection by the Community Development Director, or their designee, to confirm that the materials have been sufficiently removed to ensure compliance with the Surface Water Protection Ordinance.**
- d. **Within three months of the installation of the level spreader and other stormwater management mechanisms, a letter stamped by a Professional Engineer licensed in the State of NH shall be submitted to the Community Development Department stating that the stormwater management systems were installed and function appropriately."**





# City of Keene, NH Site Plan Application

If you have questions about how to complete this form, please call: (603) 352-5440 or email: [communitydevelopment@keene.nh.gov](mailto:communitydevelopment@keene.nh.gov)

## SECTION 1: PROJECT INFORMATION

<b>PROJECT NAME:</b> Cheshire County Shooting Sports Education Foundation		<b>TYPE OF APPLICATION BEING SUBMITTED:</b>	
<b>PROJECT ADDRESS(ES):</b> 19 Ferry Brook Road		<input checked="" type="checkbox"/> MAJOR PROJECT APPLICATION <input type="checkbox"/> MINOR PROJECT APPLICATION	
<b>EXISTING OR PREVIOUS USE:</b> Shooting Range		<b>PROPOSED USE:</b> Shooting Range	
<b>GROSS FLOOR AREA OF NEW CONSTRUCTION</b> (in square feet) 0		<b>GROSS FLOOR AREA OF EXISTING BUILDINGS/STRUCTURES</b> (in square feet) 465 sf, and 4618 sf	
<b>AREA OF PROPOSED NEW IMPERVIOUS SURFACES</b> (in square feet) 0		<b>TOTAL AREA OF LAND DISTURBANCE</b> (in square feet) 15,000 SF	

## SECTION 2: CONTACT INFORMATION

PROPERTY OWNER	APPLICANT
<b>NAME/COMPANY:</b> CCSSEF, Inc.	<b>NAME/COMPANY:</b> same
<b>MAILING ADDRESS:</b> P.O. Box 233, Keene, NH 03431	<b>MAILING ADDRESS:</b>
<b>PHONE:</b> 603-352-8563	<b>PHONE:</b>
<b>EMAIL:</b> otto.busher@ccssef.org	<b>EMAIL:</b>
<b>SIGNATURE:</b> 	<b>SIGNATURE:</b>
<b>PRINTED NAME:</b> Otto Busher III	<b>PRINTED NAME:</b>

AUTHORIZED AGENT (if different than Owner/Applicant)	FOR OFFICE USE ONLY:	
<b>NAME/COMPANY:</b> Liza Sargent/SVE Associates	<b>TAX MAP PARCEL #(s):</b> 214 021 000 000 000	
<b>MAILING ADDRESS:</b> P.O. Box 1818, Brattleboro, VT 05302	-----	
<b>PHONE:</b> 802-257-0561	<b>PARCEL SIZE:</b> 55 ac	<b>DATE STAMP:</b>
<b>EMAIL:</b> lsargent@sveassoc.com	<b>ZONING DISTRICT:</b> RUVAD	
<b>SIGNATURE:</b> 	<b>PROJECT #:</b> SPR-01-13, Mod. 3	
<b>PRINTED NAME:</b> Liza Sargent		

## SECTION 3: APPLICATION SUBMISSION REQUIREMENTS

**A COMPLETE APPLICATION MUST INCLUDE THE FOLLOWING ITEMS. APPLICATION MATERIALS MUST BE SUBMITTED BOTH PHYSICALLY & DIGITALLY AS OUTLINED IN THE ATTACHED DOCUMENTS.**

- **Email:** communitydevelopment@keenenh.gov, with "Planning Board Application" in the subject line
- **Mail / Hand Deliver:** Community Development (4th Floor), Keene City Hall, 3 Washington St, Keene, NH 03431

The submittal requirements for Planning Board applications are outlined further in **Article 20** and **Article 25.12** of the [Land Development Code \(LDC\)](#). You may request an exemption from providing any of the items below, except the application fee, notice list, narrative, and mailing labels. The Community Development Director may grant an exemption, if it is determined that the scope of the project does not warrant the submittal.

*Note: Additional information may be requested by the respective decision-making authority during the review process.*

### GENERAL SUBMITTAL REQUIREMENTS

**CERTIFIED NOTICE LIST** (See **Attachment A** for more information.)

**2 SETS OF MAILING LABELS** (See **Attachment A** for more information.)

**PROJECT NARRATIVE** (See **Section 1 of Attachment B** for more information.)

**FEES:** Fill in the information below to calculate the total fee.

\$250 base fee  
 \$0.05 per-sf of new construction x 465 sf of new construction  
 \$62 legal ad fee  
 4.98 current USPS certified mailing rate x 12 abutters  
 = 395.01 (TOTAL FEE)

**NOTE:** Please call the Community Development Department for the current certified mailing rate. Checks should be made payable to the *City of Keene*. Credit card payments are accepted in-person or by calling 603-352-5440.

**WAIVERS** (See **Section 2 of Attachment B** for additional information.)

- WAIVER(S) REQUESTED**  
 **NO WAIVER(S) REQUESTED**

PLAN SETS (See Attachment C for additional information.)	SUBMITTED	EXEMPTION REQUESTED
LOCATION MAP OF PROPOSED IMPROVEMENTS	X	
EXISTING CONDITIONS PLAN	X	
PROPOSED CONDITIONS PLAN	X	
GRADING PLAN	X	
LANDSCAPING PLAN		X
LIGHTING PLAN		X
ELEVATIONS		X
TECHNICAL REPORTS (See Attachment C for additional information.)	SUBMITTED	EXEMPTION REQUESTED
DRAINAGE REPORT	X	
TRAFFIC ANALYSIS		X
SOIL ANALYSIS		X
HISTORIC EVALUATION		X
SCREENING ANALYSIS		X
ARCHITECTURAL & VISUAL APPEARANCE ANALYSIS		X
OTHER REPORTS / ANALYSES		X

# SVE Associates

---

Engineering \* Surveying \* Landscape Architecture \* Planning

---

## Project Narrative

### Cheshire County Shooting Sports Education Foundation SVE Project 2695A

January 9, 2024

*Revised February 9, 2024*

Cheshire County Shooting Sports Education Foundation is proposing several changes to their approved site plan SPR-01-13, Modification #2, at 19 Ferry Brook Road. Changes include relocating the stormwater level spreader to the bottom of the slope, change of light pole location, confirmation of location of ADA parking space and access isle, confirmation of proposed bike rack location, locating the existing classroom trailer and proposed stockade fence for screening, and locating the existing berm. *The existing berm was constructed from surplus material from onsite. It was shaped using on-site equipment. The berm historically has been used occasionally as an overflow range, and for a half dozen public events per year. The proposed use would be the same continued use.*

The site today is a shooting sports education facility. Stormwater from the previously approved building addition, plus the classroom trailer and a portion of the berm will sheet flow to the proposed level spreader. There is no discharge to City drainage systems and no direct discharge to the river. There is no measurable increase in stormwater runoff from the proposed site improvements.

There are no proposed changes to traffic as a result of these site modifications.

*The ADA space noted during the November 2022 staff visit has been obliterated, as it was not compliant (no accessible isle).*

*SPR-01-13, Mod. 2, site plan application conditionally approved in August 2020 for the ~3,300 sf indoor shooting range with the proposed exterior cladding for the addition was red CMU block. Tan vinyl siding was installed in lieu of the red CMU block.*

*SPR-01-13, Mod. 2, showed 3 pole mounted light fixtures. One pole is located on the south side of the parking lot, one on the east side and one on the northwest side of the parking lot. Poles were installed in the south and east side of the parking, and the pole in question was installed north of the parking lot, on the east side of the drive to the ranges.*

*In order to make maintenance of rooftop units easier, a concrete pad is proposed with stairs to the roof along the northwest side of the indoor range.*

### **SVE Associates**

---

Engineering \* Surveying \* Landscape Architecture \* Planning  
439 West River Road, P.O. Box 1818, Brattleboro, VT 05302 Phone: (802) 257-0561

---

# **Development Standards Narrative**

## **Cheshire County Shooting Sports Education Foundation, Inc.**

SVE Project # K2695A

January 15, 2024

*Revised February 9, 2024*

Cheshire County Shooting Sports Education Foundation is proposing several changes to their approved site plan SPR-01-13, Modification #2, at 19 Ferry Brook Road. The site is and will continue to be a shooting sports education facility. Changes include relocating the stormwater level spreader to the bottom of the slope, change of light pole location, confirmation of location of ADA parking space and access isle, confirmation of proposed bike rack location, locating the existing classroom trailer and proposed stockade fence for screening, and locating the existing berm not previously shown on the site plan. *A concrete pad is proposed for the installation of rooftop stairs for maintenance of the rooftop units.*

2. **Drainage:** There will not be an increase in stormwater runoff. Stormwater from the previously approved building addition, plus the classroom trailer and a portion of the berm will sheet flow to the proposed level spreader at the bottom of the slope. There is no discharge to City drainage systems. See attached narrative.
3. **Sedimentation/ Erosion Control:** The berm will be seeded and mulched. Silt fence shall be installed at base of berm and level spreader until vegetation is established. The landowner shall monitor and repair erosion control measures on a regular basis.
4. **Snow Storage and Removal:** Snow will be stored on-site.
5. **Landscaping:** No changes proposed.
6. **Screening:** A wooden stockade fence is proposed on the two sides of the classroom trailer to screen it from view from the driveway. The other two sides cannot be seen by the general public.
7. **Lighting:** The installed light locations are shown on the attached site plan. No changes are proposed.
8. **Water and Sewer:** No change.
9. **Traffic and Access Management:** No change.
10. **Filling and Excavation:** There will be fill for the emergency spillway to the proposed level spreader.

### **SVE Associates**

---

---

Engineering	*	Surveying	*	Landscape Architecture	*	Planning
439 West River Road, P.O. Box 1818, Brattleboro, VT 05302 Phone: (802) 257-0561 Fax (802) 257-0721						

11. Surface Waters and Wetlands: The existing bolder pile will be removed from the 75' wetland buffer. *Portions of the topsoil stockpile and gravel berm within the 75' wetland buffer shall be removed.*
12. Hazardous and Toxic Materials: There will not be any hazardous or toxic materials stored onsite.
13. Noise: No change.
14. Architecture and Visual Appearance: The classroom trailer will be screened from view. Access to the classroom is through the clubhouse. See attached photo. *The ~3,300 sf indoor shooting range, installed in 2020 has tan vinyl siding in lieu of the red CMU block that was approved under spr-01-13, Mod. 2.*

---

---

**SVE Associates**

Engineering \*      Surveying \*      Landscape Architecture \*      Planning  
439 West River Road, P.O. Box 1818, Brattleboro, VT 05302      Phone: (802) 257-0561      Fax (802) 257-0721



Photo of clubhouse, indoor shooting range and classroom trailer. Classroom to be screened by stockade fence.

---

---

## SVE Associates

Engineering \* Surveying \* Landscape Architecture \* Planning  
439 West River Road, P.O. Box 1818, Brattleboro, VT 05302 Phone: (802) 257-0561 Fax (802) 257-0721

# CHESHIRE COUNTY SHOOTING SPORTS EDUCATION FOUNDATION

19 FERRY BROOK ROAD, KEENE, NEW HAMPSHIRE



*Liza Sargent* 2/9/24

LIZA P. SARGENT DATE  
R.C.E. NUMBER: 13365

APPLICANT:

## CCSSEF

P.O. BOX 233  
KEENE, NH 03431  
(603) 352-8563

SVE Project #:K2695A

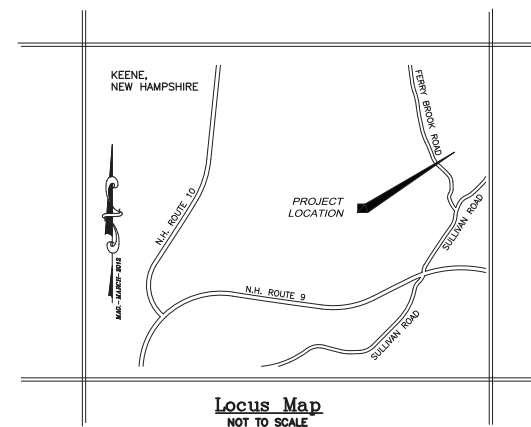

### INDEX OF PLANS

- N-1 NOTES & LEGEND
- S-1 EXISTING CONDITIONS
- C-1 SITE PLAN

PREPARED BY

Civil Engineer:

### SVE Associates

439 West River Road  
Brattleboro, Vermont 05302

PHONE (802) 257-0561  
FAX (802) 257-0721

January 15, 2024  
revised thru February 9, 2024

APPROVED BY THE APPLICANT:

ON \_\_\_\_\_

INSPECTION PERMISSION: UPON APPROVAL OF THIS  
SITE PLAN, THE OWNER GRANTS PERMISSION FOR THE  
MEMBERS OR AGENTS OF THE KEENE PLANNING  
BOARD TO INSPECT THIS SITE AS NECESSARY.

APPROVED BY THE KEENE PLANNING BOARD

ON \_\_\_\_\_

CERTIFIED BY CHAIRMAN \_\_\_\_\_ 47 of 70

**GENERAL CONSTRUCTION NOTES:**

1. THE CONTRACTOR SHALL CALL DIG-SAFE, AT 1-888-344-7233 AT LEAST 72 HOURS BEFORE THE START OF EXCAVATION.
2. THE CONTRACTOR IS EXPECTED TO BE AWARE OF AND COMPLY WITH ALL PERMITS AND PERMIT CONDITIONS.
3. ALL TRENCHING, EXCAVATION, SHEETING, SHORING, ETC. SHALL COMPLY WITH THE MOST CURRENT OSHA REGULATIONS.
4. THE CONTRACTOR SHALL NOTIFY SVE ASSOCIATES IF FIELD CONDITIONS VARY FROM THAT SHOWN ON THE PLAN(S). THE CONTRACTOR'S WORK SHALL NOT VARY FROM THE PLAN(S) UNLESS SO AUTHORIZED BY SVE ASSOCIATES.
5. ALL WORK SHALL BE COMPLETED IN ACCORDANCE WITH SITE PLANS AND SPECIFICATIONS PROVIDED OR IN ACCORDANCE WITH NH DEP'T OF TRANSPORTATION STANDARD SPECIFICATIONS FOR ROAD AND BRIDGE CONSTRUCTION, LATEST EDITION.
6. IN CASE OF CONFLICTS, THE MOST STRINGENT INTERPRETATION OF THE PLANS, SPECIFICATIONS, LOCAL OR STATE REGULATIONS, OR PERMIT CONDITIONS SHALL APPLY. THE ENGINEER SHALL BE THE DETERMINANT AS TO WHAT APPLIES.
7. ALL KNOWN SUBSURFACE UTILITIES AND STRUCTURES HAVE BEEN INDICATED ON THE PLAN(S) AS ACCURATELY AS POSSIBLE. THE EXACT LOCATION MAY VARY AND THE CONTRACTOR IS CAUTIONED TO PROCEED WITH CARE.
8. CONTRACTOR SHALL VERIFY ALL BENCH MARKS, INVERTS, PIPES AND STRUCTURES ELEVATIONS PRIOR TO START OF WORK. IMMEDIATELY NOTIFY SVE ASSOCIATES IF THE FIELD INFORMATION DOES NOT MATCH PLAN INFORMATION.
9. THE OWNER WILL PROVIDE BENCH MARKS. THE CONTRACTOR WILL BE RESPONSIBLE FOR ALL OTHER LAYOUT AND FOR REPLACEMENT OF LAYOUT COMPLETED BY THE OWNER.
10. CONTRACTOR SHALL PROVIDE A FULL SET OF AS-BUILT DRAWINGS TO THE OWNER WITH SWING TIES OR COORDINATES, LOCATING ALL VALVES, FITTINGS, STRUCTURES, PIPES, ETC. THE AS-BUILTS SHALL INDICATE MATERIALS, PIPE LENGTHS INSTALLED, ALL INVERTS, AND ALL STRUCTURE ELEVATIONS. ACCEPTANCE OF THE WORK IS SUBJECT TO ACCEPTANCE OF THE AS-BUILTS BY THE ENGINEER AND OWNER.
11. THE CONTRACTOR SHALL BE RESPONSIBLE FOR ALL DE-WATERING AT NO ADDITIONAL COST TO THE OWNER.
12. ALL SURFACES SHALL BE GRADED TO DRAIN.
13. THE CONTRACTOR SHALL RESTORE ALL DISTURBED SURFACES TO THEIR ORIGINAL CONDITION OR BETTER. ALL NEW AND EXISTING PIPES AND STRUCTURES SHALL BE CLEANED.

**SEDIMENT AND EROSION CONTROL NOTES:**

1. INSTALL ALL SEDIMENT & EROSION CONTROL MEASURES IN ACCORDANCE WITH MANUFACTURER'S DIRECTION OR DETAILS PROVIDED. PERIMETER CONTROLS MUST BE INSTALLED PRIOR TO EARTH MOVING OPERATIONS.
2. THE CONTRACTOR IS RESPONSIBLE FOR ALL EROSION CONTROL. THE CONTRACTOR SHALL TAKE ALL MEASURES NEEDED TO MINIMIZE EROSION TO THE GREATEST EXTENT POSSIBLE, AT NO ADDITIONAL COST TO THE OWNER, REGARDLESS OF DETAIL SHOWN ON THESE PLANS.
3. CONTRACTOR SHALL INSPECTION AND REPAIR ALL SEDIMENT AND EROSION CONTROL MEASURES DAILY WHILE UNDER CONSTRUCTION, THEN AFTER EACH RAINFALL OR 0.5" IN 24 HOURS AND NOT LESS THAN ONCE A WEEK THEREAFTER UNTIL ALL UPHILL SOILS ARE WELL STABILIZED.
4. SEED, FERTILIZE & MULCH ALL FINISH GRADED AREAS WITHIN 72 HOURS OF FINISH GRADING.
5. SEDIMENT CONTROLS AND/OR SILT FENCES SHALL BE REPLACED WHEN CLOGGED AND NO LONGER FUNCTIONAL.
6. SEDIMENT CONTROLS AND/OR SILT FENCES SHALL REMAIN IN PLACE UNTIL ALL UPHILL VEGETATED AREAS ARE STABILIZED.
7. ALL SOIL STOCKPILES SHALL BE SEEDED AND MULCHED IF LEFT IN PLACE MORE THAN 21 DAYS.
8. SEEDING OF ALL DISTURBED AREAS SHALL BE COMPLETED NOT LATER THAN OCTOBER 15TH.
9. STABILIZATION OF ALL WORK AREAS SHALL BE COMPLETED NOT MORE THAN 45 DAYS FOLLOWING THE START OF WORK.
10. ALL SOIL SLOPES STEEPER THAN 3:1 SHALL BE COVERED WITH EROSION CONTROL FABRIC, S150 FROM NORTH AMERICAN GREEN OR APPROVED EQUAL.
11. STABILIZE ALL DRAINAGE SWALES, LEVEL SPREADERS, BERMS, AND DITCHES PRIOR TO DIRECTING RUNOFF TO THEM.
12. CONTRACTOR SHALL IMMEDIATELY REPAIR OR REPLACE SEDIMENT AND EROSION CONTROLS AS REQUESTED BY THE ENGINEER.

**PROJECT SPECIFIC NOTES:**

1. SEEDING OF ALL DISTURBED AREAS SHALL BE COMPLETED NOT LATER THAN OCTOBER 15TH.
2. SEEDING OF ALL FINISHED AREAS SHALL BE COMPLETED NOT MORE THAN 72 HOURS AFTER FINISH GRADING.
3. STABILIZATION OF ALL WORK AREAS SHALL BE COMPLETED NOT MORE THAN 45 DAYS FOLLOWING THE START OF WORK.
4. STABILIZE ALL DRAINAGE SWALES PRIOR TO DIRECTING RUNOFF TO THEM.

**SEED SPECIFICATIONS**

**PERMANENT SEED:**

<u>ALL MOWABLE AREAS:</u> PARK SEED NHDOT TYPE 15	
CREeping RED FESCUE	40 LB/AC
PERENNIAL RYEGRASS	50 LB/AC
KENTUCKY BLUEGRASS	25 LB/AC
REDTOP	5 LB/AC
TOTAL:	120 LB/AC
<u>ALL SLOPES 5:1 OR STEEPER:</u> SLOPE SEED NHDOT TYPE 45 (OR OTHER WILDFLOWER MIX APPROVED BY ENGINEER)	
CREeping RED FESCUE	35 LB/AC
PERENNIAL RYEGRASS	30 LB/AC
REDTOP	5 LB/AC
ALSIKE CLOVER	5 LB/AC
LANCE-LEAVED COREOPSIS	5 LB/AC
OXEYE DAISY	3 LB/AC
BUTTERFLY WEED	3 LB/AC
BLACKEYED SUSAN	3 LB/AC
WILD LUPINE	3 LB/AC
TOTAL:	95 LB/AC

**SEQUENCE OF WORK**

THE SEQUENCE OF WORK SHALL BE FOLLOWED WITHIN EACH PHASE OF THE PROJECT. AT NO TIME OR PLACE SHALL PROJECT PHASING SUPERCEDE SOUND SEDIMENT AND EROSION CONTROL PLANNING.

1. INSTALL SILT FENCE IN ACCORDANCE WITH MANUFACTURER'S DIRECTIONS, IN LOCATIONS DETAILED ON THIS PLAN OR AS ORDERED BY THE ENGINEER.
2. INSTALL NEW LEVEL SPREADER.
3. CONSTRUCT NEW STOCKADE FENCE & BIKE RACK IN ACCORDANCE WITH APPROVED PLANS.
4. LOAM AND SEED DISTURBED AREAS, STABILIZE SLOPES WITH MATTING WHERE SPECIFIED.
5. REMOVE SILT FENCE AFTER ALL UPHILL SOILS ARE STABILIZED.

**SITE DATA TABLE**

KEENE TAX MAP #:	904-02-001-0000,
SULLIVAN TAX MAP #:	5-010-000
	5,641,020 SQ. FT. ± 129.5± ACRES
<u>ZONE:</u>	RURAL
<u>LOT SIZE:</u>	<u>AVAILABLE:</u> 129.5 <u>REQUIRED:</u> 5 AC
<u>FRONTAGE:</u>	> 50 FEET 50 FEET
<u>LOT WIDTH:</u>	> 200 FEET 200 FEET
<u>BLDG. HEIGHT:</u>	<u>ALLOWED:</u> 35 FT <u>PROPOSED:</u> < 35 FEET
<u>BUILDING SETBACKS:</u>	
FRONT:	50'
REAR:	50'
SIDES:	50'
<u>LOT COVERAGE:</u>	<u>MAXIMUM:</u> 10% (239,580 S.F./ 5.5 AC) <u>PROPOSED:</u> 0.2% (7,235 S.F./ 0.17 AC)
BUILDINGS:	20% (479,160 S.F./ 11 AC) 1.9% (47,500 S.F./ 1.1 AC)
GRAVEL/PAVEMENT:	20% (479,160 S.F./ 11 AC) 2.3% (54,735 S.F./ 1.26 AC)
TOTAL IMPERMEABLE:	
<u>PARKING:</u>	<u>REQUIRED:</u> 1 PER 500 SF ASSEMBLY SPACE 4,600 SF/500 = 10 PLUS 2 SPACES PER CLASSROOM FOR A PRIVATE SCHOOL 10 + 2 = 12 SPACES <u>PROPOSED:</u> 15 SPACES (OF WHICH 1 IS ADA)
A.D.A. ACCESSIBLE:	1 1 ADA

**PERMITS REQUIRED:**

KEENE PLANNING BOARD  
BUILDING PERMIT

**PROPERTY OWNER  
& APPLICANT:**

CCSSEF  
P.O. BOX 233  
KEENE, NH 03431

**PREVIOUS APPROVAL:**  
SPR-01-13, MOD. 2

SYMBOL LEGEND	
<u>LINE TYPES</u>	<u>MISCELLANEOUS</u>
MAJOR CONTOUR	BUILDINGS
MINOR CONTOUR	RIP RAP
<u>POINTS</u>	
EXIST LIGHT POLE	PROP WELL
EXIST BENCHMARK	PROP SIGN

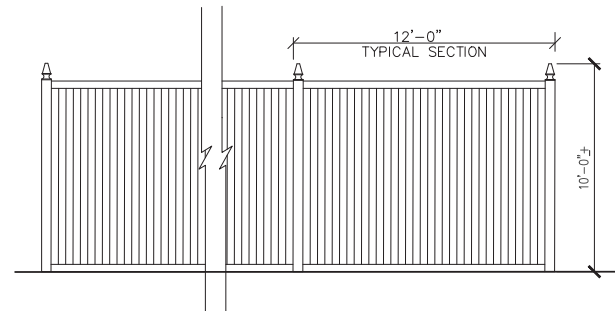

**STOCKADE FENCE**  
NOT TO SCALE

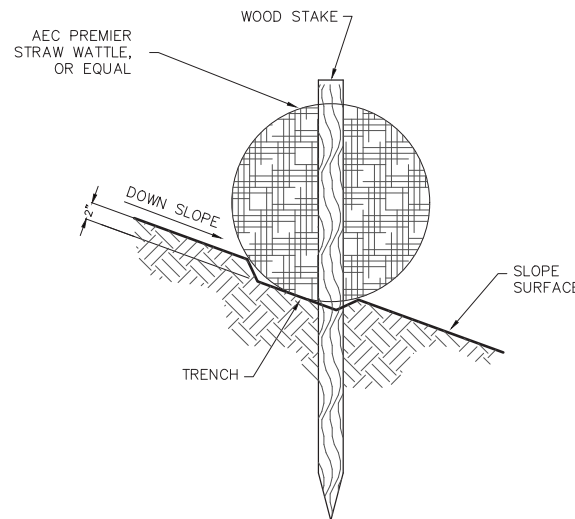

**STRAW WATTLE**  
NOT TO SCALE

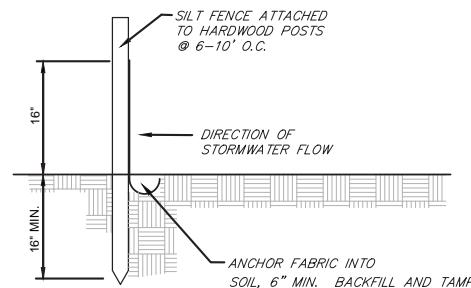

**SILT FENCE**  
NOT TO SCALE

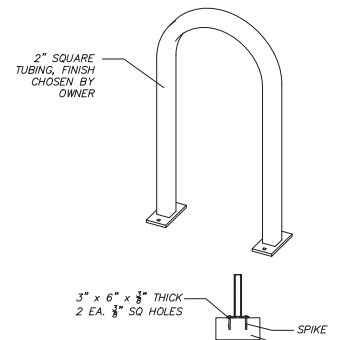

**BIKE RACK DETAIL**  
NOT TO SCALE

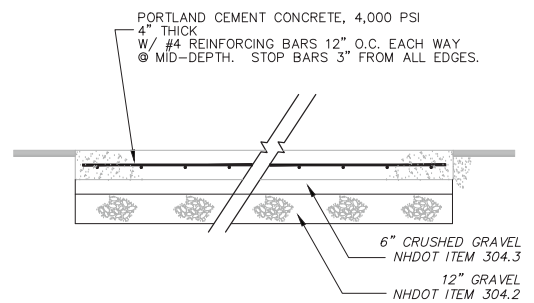

**CONCRETE PAVEMENT SECTION**  
NO SCALE



*Liza Sargent* 2/9/24  
LIZA P. SARGENT DATE  
R.C.E. NUMBER: 13365

NO.	REVISION	DATE	CHK	LPS
1	SITE DATA TABLE PARKING REQUIREMENTS	09-FEB-24		

**SVE**

Engineering  
Planning  
Landscape Architecture  
Surveying

SVE Associates  
P.O. Box 1818  
439 West River Road  
Brattleboro, VT 05302  
T 802.257.0561  
F 802.257.0721  
www.sveassoc.com

**NOTES & LEGEND**

CHESHIRE COUNTY  
SHOOTING SPORTS  
EDUCATION FOUNDATION, INC  
19 FERRY BROOK ROAD  
KEENE, NEW HAMPSHIRE

PROJ. #:  
K2695A  
DATE:  
5 - JAN - 24

SHEET

DRAWN: AJG  
CHECKED: LPS  
48 of 70

**N-1**



Drawing name: P:\Project\NH PROJECTS\K2695A Cheshire County Fish & Game Club\DWG\K2695A SITE rev.1.dwg Feb 08, 2024 - 9:47am

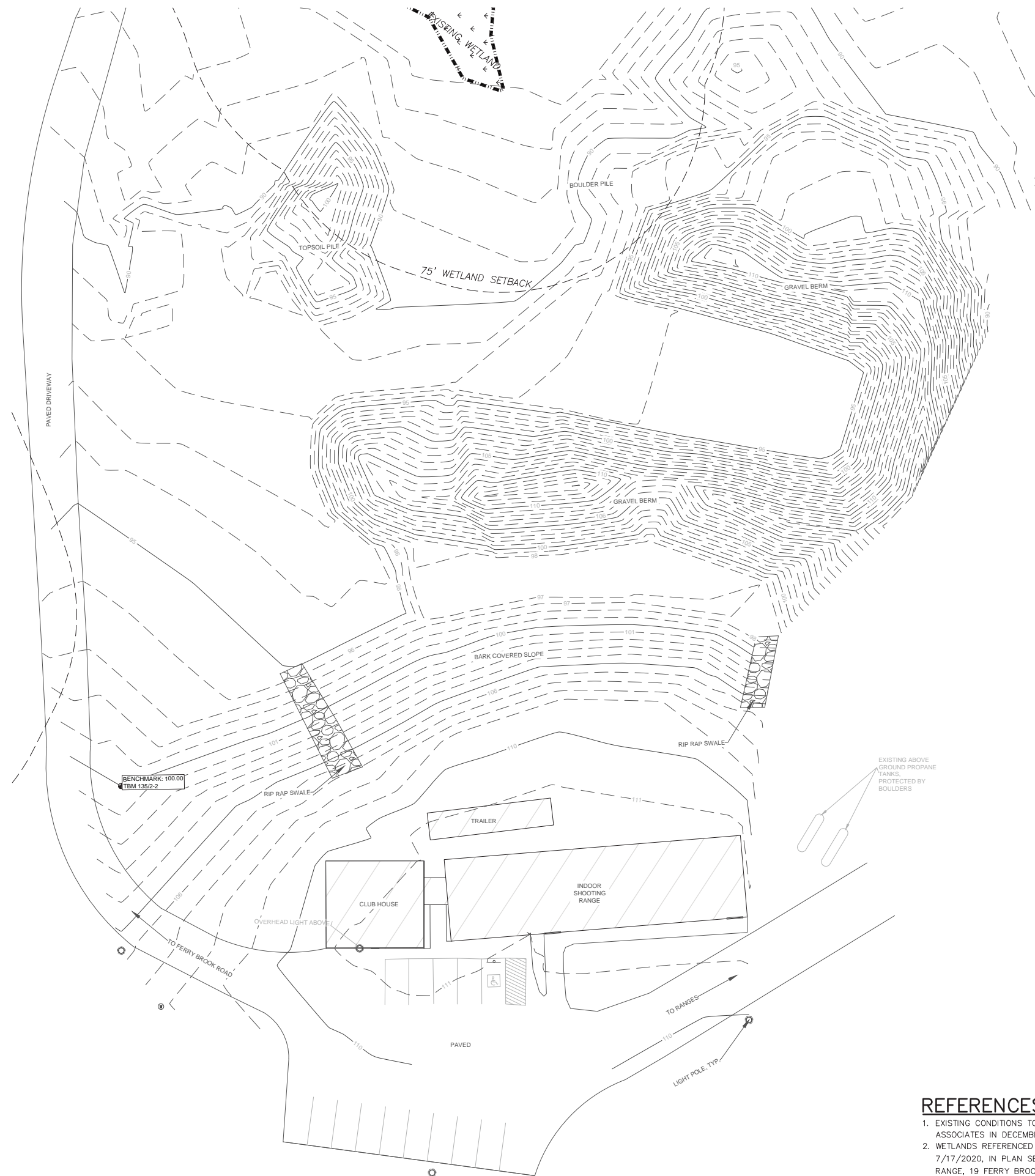

**REFERENCES:**

1. EXISTING CONDITIONS TOPOGRAPHIC SURVEY PREPARED BY SVE ASSOCIATES IN DECEMBER 2023 AND JANUARY 2024.
2. WETLANDS REFERENCED FROM SHEET 3 SEPTIC PLAN DATED 7/17/2020, IN PLAN SET "PROPOSED INDOOR SHOOTING RANGE, 19 FERRY BROOK ROAD, KEENE, NH", BY BRICKSTONE LAND USE CONSULTANTS, LLC.

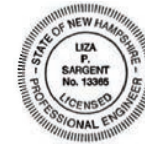

*Liza Sargent* 2/9/24

LIZA P. SARGENT DATE  
R.C.E. NUMBER: 13365

NO.	REVISION	DATE	DWN	CHK
1	PB STAFF COMMENTS	08-FEB-24	LPS	LPS

**SVE** ©2024

Engineering  
Planning  
Landscape Architecture  
Surveying

SVE Associates  
P.O. Box 1818  
439 West River Road  
Brattleboro, VT 05302  
T 802.257.0561  
F 802.257.0721  
www.sveassoc.com

**EXISTING CONDITIONS**

CHESHIRE COUNTY  
SHOOTING SPORTS  
EDUCATION FOUNDATION, INC  
19 FERRY BROOK ROAD  
KEENE, NEW HAMPSHIRE

0 10 20 40  
GRAPHIC SCALE 1" = 20'

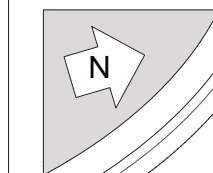

PROJ. #  
K2695A

DATE:  
5 - JAN - 24

SHEET

DRAWN: AJG  
CHECKED: LPS

**S-1**  
49 of 70



**OVERFLOW PARKING NOTE:**

OVERFLOW PARKING WILL BE PROVIDED IN THE GRAVEL AREA NEXT TO THE LEACHFIELD AND ACROSS THE DRIVEWAY FROM THE LEACHFIELD.

**LEGEND**

- SIGN
- UTILITY POLE
- GUY ANCHOR
- WELL
- SEWER MANHOLE
- EXISTING CONTOUR LINE
- EDGE OF WET AREA
- OVERHEAD UTILITIES
- APPROX. UNDERGROUND UTILITIES
- THRESHOLD ELEVATION

**GRAPHIC SCALE**

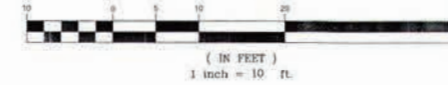

**FINAL**

Site Plan Review  
 Approved: *[Signature]*  
 Date: 11/2/20  
 Comments:

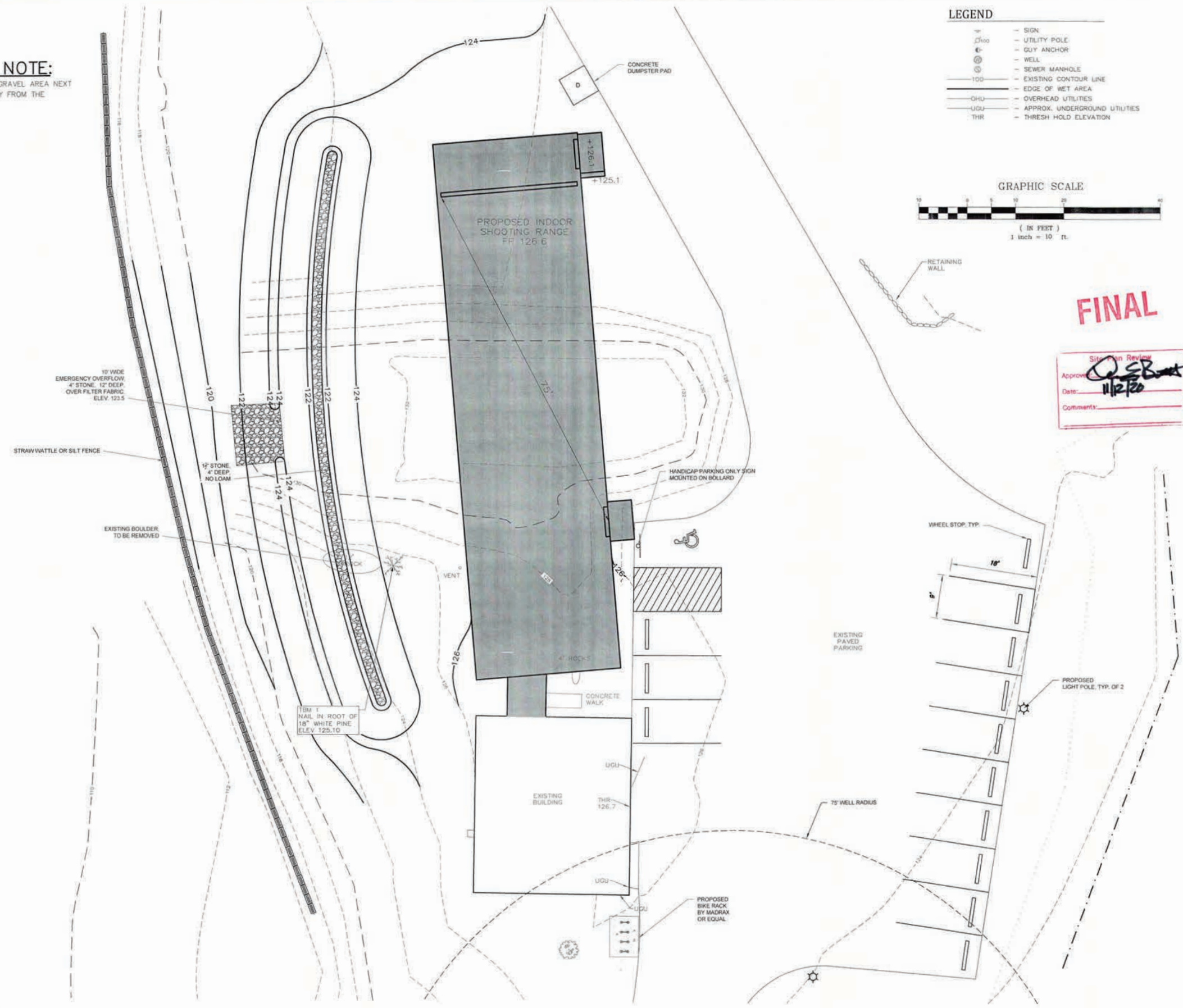

REVISIONS: DATE:  
 ADDED WHEEL STOPS, BOLLARD & ADA SPACE 8/7/20  
 ADDED PARKING SPACES 8/13/20

OWNER/DEVELOPER  
**CHESHIRE COUNTY SHOOTING SPORTS EDUCATION FOUNDATION**  
 PO BOX 233  
 KEENE, NH 03431

ENGINEER  
**SVE**  
 SVE Associates  
 P.O. Box 1818  
 439 West River Road  
 Brattleboro, VT 05302  
 T: 802.257.0561  
 www.sveassoc.com

PLANNER  
**Brickstone Land Use Consultants, LLC**  
 Site Planning, Permitting and Development Consulting  
 185 Winchester Street, Keene, NH 03431  
 Phone: (603) 351-0110

PROPOSED INDOOR SHOOTING RANGE  
 19 FERRY BROOK ROAD  
 KEENE, NH

**PROPOSED CONDITION PLAN**

SCALE: 1"=10'

DATE: 7/17/2020

SHEET 2

SPR-01-13, Mod. 2



## Drainage Summary

for

**Cheshire County Shooting Sports Education Foundation, Inc.  
19 Ferry Brook Road, Keene, NH**

**Prepared by SVE Associates  
January 9, 2024**

A comparison of peak stormwater runoff for the 25-year rainfall events in the post-development conditions was completed by SVE Associates using HydroCad 10.0 software. The storm event used in the model was Type III, 24-hour storm with the following rainfall depths for Keene, NH:

25 Year Event: 4.95 inches

### OVERVIEW:

This project consists of permitting the existing classroom and constructing the level spreader designed for both the indoor shooting range (already constructed) at the 19 Ferry Brook Road property. No other changes are proposed to the developed property.

### EXISTING CONDITIONS:

For this drainage analysis, the existing conditions consist of lawn and mulched slope. Stormwater runoff sheet flows downhill.

### PROPOSED CONDITIONS:

The proposed conditions, modeled in the "Post-Development" drainage model, consist of the existing indoor shooting range addition, and existing classroom trailer that sheet flow to the proposed level spreader with emergency overflow. The entire 25-year storm is detained within the proposed level spreader.

### CONCLUSION:

There will be no adverse impact to downstream abutters due to stormwater runoff from the indoor shooting range and classroom trailer. Runoff in the 25-year storm is detained in the proposed level spreader. From the Hydrocad model, there is no outflow. There is no significant change in stormwater runoff post development.

### **SVE Associates**

---

---

Engineering \* Surveying \* Landscape Architecture \* Planning  
P.O. Box 1818, Brattleboro, VT 05302 Phone: (802) 257-0561 Fax (802) 257-0721 E-mail [svek@sveassoc.com](mailto:svek@sveassoc.com)  
P:\Project\NH PROJECTS\K2695A Cheshire County Fish & Game Club\Hydrocad\K2695A Drainage Summary PB.doc

# STAFF REPORT

## SPR-04-21, MODIFICATION #3 – SITE PLAN – HUNDRED NIGHTS SHELTER, 122 WATER ST

### Request:

Applicant BCM Environmental & Land Law PLLC, on behalf of owners the Hundred Nights Foundation Inc, the Railroad Street Condominium Association, and the City of Keene, proposes to install security lighting around the perimeter of the Hundred Nights site at 122 Water St (TMP #585-027-000). Waivers are requested from Section 20.7.3.C & Section 20.7.3.F.1.c of the LDC regarding light trespass onto the adjacent properties at 0 Water St & 0 Cypress St (TMP#s 574-041-000 & 585-026-000) and lighting hours of operation. The Hundred Nights site is 0.62 ac and is located in the Downtown Growth District.

### Background:

The subject parcel is located in east Keene at the intersection of Community Way to the west and Water St to the south. A mix of commercial and residential uses abut this lot on all sides. The site serves as the new home of the ~15,000-sf Hundred Nights Shelter, which occupies the southwestern corner of the parcel. The parking area occupies the northern section of the lot and the southeastern portion of the lot serves as outdoor space for the shelter. Figure 1 shows a snippet of the most recently approved plan that was submitted as part of SPR-04-21 Modification #1, an Administrative Planning application that was approved by Planning Staff in September 2022.

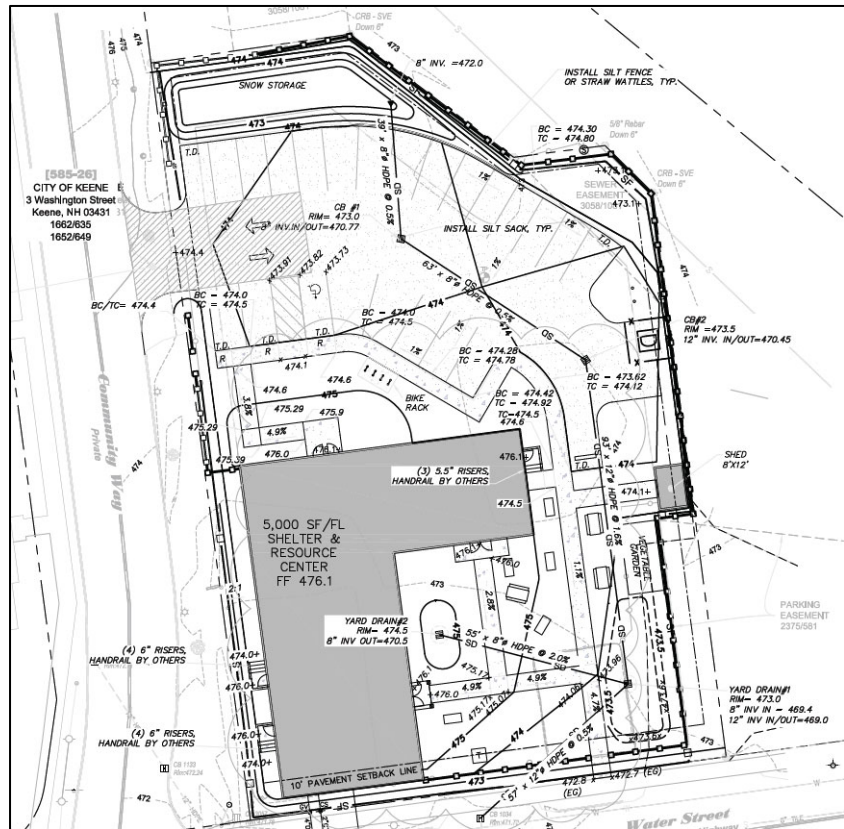

Figure 1. A snippet of the most recent plan reviewed by staff as part of the Administrative Planning application, SPR-04-21 Mod. 1.

The purpose of this application is to install eight new full cut-off security light fixtures along the northern and northeastern sections of the fence and two new building-mounted full cut-off light fixtures at the southwestern corner of the building. Waivers are requested from Section 20.7.3.C of the Land Development Code (LDC) due to light trespass onto the adjacent properties at 0 Cypress St (TMP #517-041-000) owned by the Railroad Street Condominium Association and 0 Water St (TMP #585-026-000) owned by the City of Keene. A second waiver is requested from Section 20.7.3.F.1.c of the LDC regarding the proposed hours of operation of the lighting.

## STAFF REPORT

### **Determination of Regional Impact:**

After reviewing the application, staff have made a preliminary evaluation that the proposed site plan does not appear to have the potential for “regional impact” as defined in RSA 36:55. The Board will need to make a final determination as to whether the proposal, if approved, could have the potential for regional impact.

### **Completeness:**

The Applicant has requested exemptions from submitting a grading plan, landscaping plan, elevations, drainage report, traffic analysis, soil analysis, historic evaluation, screening analysis, and architectural & visual appearance analysis. After reviewing each request, staff recommend that the Board grant the requested exemptions and accept the application as “complete.”

### **Departmental Comments:**

- **Code Enforcement:** A building permit will be required prior to the installation of the new lighting.

**Application Analysis:** The following is a review of the how the proposal complies with the Planning Board’s lighting standards, which are outlined under Article 20.7 of the LDC. This is the only Site Development Standard relevant to the review of this application.

### **“Sect. 20.7.2 Prohibited**

1. *Floodlighting is prohibited, unless:*
  - a. *The Community Development Director, or their designee, determines that there will be no negative impact upon motorists and neighboring properties; and*
  - b. *The lights are directed toward the rear of a lot away from the road and neighboring properties, and are placed on heat or motion sensors.*
2. *Uplighting is prohibited.”*

The Applicant is not proposing to install floodlights or uplight the property in any way. This standard appears to be met.

### **“Sect. 20.7.3 General Standards**

- A. **Shielding:** *All outdoor lights, including freestanding and wall mounted, shall be fully-shielded and/or dark skies compliant (International Dark Sky Association Seal of Approval or equivalent) fixtures with no portion of the bulb visible.”*

The Applicant is proposing to install ten new light fixtures in total – eight fixtures will be installed along the northern and northeastern sections of the fence around the perimeter of the property and two fixtures will be installed at the southwestern corner of the building. The proposed light fixture is full cut-off with a color temperature of 3,000K and will be mounted at a height of 10’ above grade on both the fence and building. This standard appears to be met.

- B. **Glare:** *Lighting shall be installed and directed in such a manner as to prevent glare at any location, on or off the property.”*

The Applicant is not proposing to install the new light fixtures in such a way that glare will be created; however, they have submitted a request for a waiver from Section 20.7.3.C of the LDC

## STAFF REPORT

because of increased light levels of light trespass onto the adjacent properties to the north, east, and west, which is addressed later on in the staff report. This standard appears to be met.

- C. **“Light Trespass:** *The maximum light level of any light fixture cannot exceed 0.1-footcandle measured at the property line and cannot exceed 1-footcandle measured at the right-of-way line of a street.”*

The photometric plan that was submitted shows that the light trespass levels onto the adjacent railroad condo parcel at 0 Cypress St to the north and east of the Hundred Nights site will be in excess of approximately 4-7 footcandles in various locations along the fence line. At the southwestern corner of the parcel, the light trespass levels will exceed ~6-7 footcandles onto the City-owned parcel at 0 Water St to the west and the public right-of-way to the south. Given that the proposal will not comply with the requirements in this section of the lighting standards, the Applicant has submitted a waiver request that is included as an attachment to this staff report.

In deciding whether or not to grant this waiver request, the Board should find by a majority vote that the criteria outlined in Section 25.10.4 of the LDC have been met:

- “1. Specific circumstances relative to the subdivision, or conditions of the land in such subdivision, indicate that the waiver will properly carry out the spirit and intent of the regulations; and,*
- 2. Granting the waiver will not increase the potential for creating adverse impacts to abutters, the community or the environment; and,*
- 3. Consideration will also be given as to whether strict conformity with the regulations would pose an unnecessary hardship to the applicant.”*

- D. **“Illumination:** *All illumination shall be of a white light and shall have a color rendering index (CRI) greater than 70. The color-temperature or correlated color temperature (CCT) of lighting shall not exceed 3,500 Kelvins.”*

The light fixture that the Applicant is proposing to install has a color temperature of 3,000K. This standard appears to be met.

- E. **“Height:** *The mounting height of fixtures, as measured from the finished grade to the top of the fixture or pole (inclusive of fixture) shall not exceed the maximum height listed in Table 20-1.”*

The photometric plan shows that all light fixtures will be installed at a height of 10’ above ground level, which is in compliance with 20’ max height requirement in the Downtown Growth District. This standard appears to be met.

A. **“Hours of Operation:**

- 1. Outdoor lighting shall not be illuminated between the hours of 10:00 pm and 6:00 am with the following exceptions:*
  - a. Security lighting, provided the average illumination on the ground or on any vertical surface does not exceed 1-footcandle.*
  - b. If the use is being operated, normal illumination shall be allowed during the activity and for not more than 1-hour before or after the activity occurs.*



## STAFF REPORT

- c. *For 24-hour businesses, lighting levels shall be reduced by a minimum of 50% between the hours of 10:00 pm and 6:00 am.*

The Applicant has requested a waiver from Section 20.7.3.F.1.c of the LDC to allow for normal lighting levels between the hours of 10:00 pm and 6:00 am to provide for higher levels of lighting around the perimeter of the property throughout the course of the night. The Board will need to make a determination if the intent of the hours of operation standards have been met using the waiver criteria included above.

### **Recommended Motion:**

If the Board is inclined to approve this request, the following motion is recommended:

**“Approve SPR-04-21, Mod. 3, as shown the photometric plans identified as “Hundred Nights Security Lighting” prepared by Charron Inc. on January 7, 2024 and last revised on January 18, 2024 with the following conditions subsequent to final approval:**

- 1. Prior to the issuance of a building permit, owners’ signatures must appear on both sheets of the final plan set.**
- 2. Prior to the issuance of a building permit, the submittal of five full-size paper copies and a digital copy of the final plan set.”**



# City of Keene, NH Site Plan Application

If you have questions about how to complete this form, please call: (603) 352-5440 or email: [communitydevelopment@keeneh.gov](mailto:communitydevelopment@keeneh.gov)

## SECTION 1: PROJECT INFORMATION

<b>PROJECT NAME:</b> Hundred Nights Perimeter Lighting		<b>TYPE OF APPLICATION BEING SUBMITTED:</b>	
<b>PROJECT ADDRESS(ES):</b> 122 Water Street		<input checked="" type="checkbox"/> MAJOR PROJECT APPLICATION <input type="checkbox"/> MINOR PROJECT APPLICATION	
<b>EXISTING OR PREVIOUS USE:</b> Homeless Shelter		<b>PROPOSED USE:</b> Homeless Shelter	
<b>GROSS FLOOR AREA OF NEW CONSTRUCTION</b> (in square feet) NA		<b>GROSS FLOOR AREA OF EXISTING BUILDINGS/STRUCTURES</b> (in square feet) 20,888	
<b>AREA OF PROPOSED NEW IMPERVIOUS SURFACES</b> (in square feet) NA		<b>TOTAL AREA OF LAND DISTURBANCE</b> (in square feet) NA	

## SECTION 2: CONTACT INFORMATION

PROPERTY OWNER	APPLICANT
<b>NAME/COMPANY:</b> Hundred Nights Foundation Inc.	<b>NAME/COMPANY:</b> Same as Owner
<b>MAILING ADDRESS:</b> 122 Water St., Keene, NH 03431	<b>MAILING ADDRESS:</b>
<b>PHONE:</b> See Authorized Agent Info.	<b>PHONE:</b>
<b>EMAIL:</b> See Authorized Agent Info.	<b>EMAIL:</b>
<b>SIGNATURE:</b> See Attached - Signed Owner Affidavit	<b>SIGNATURE:</b>
<b>PRINTED NAME:</b> David Kochman, President	<b>PRINTED NAME:</b>

AUTHORIZED AGENT (if different than Owner/Applicant)	FOR OFFICE USE ONLY:	
<b>NAME/COMPANY:</b> BCM Environmental & Land Law PLLC	<b>TAX MAP PARCEL #(s):</b> 585-027-000-000000	
<b>MAILING ADDRESS:</b> 41 School St., Keene, NH 03431	-----	
<b>PHONE:</b> (603) 352-1928	<b>PARCEL SIZE:</b> 0.162 ac	<b>DATE STAMP:</b>  By _____
<b>EMAIL:</b> hanna@nhlandlaw.com; kessler@nhlandlaw.com	<b>ZONING DISTRICT:</b> Downtown Growth	
<b>SIGNATURE:</b> Thomas R. Hanna	<b>PROJECT #:</b> SPR-04-21, Mod. 3	
<b>PRINTED NAME:</b> Tom Hanna		

## SECTION 3: APPLICATION SUBMISSION REQUIREMENTS

**A COMPLETE APPLICATION MUST INCLUDE THE FOLLOWING ITEMS. APPLICATION MATERIALS MUST BE SUBMITTED BOTH PHYSICALLY & DIGITALLY AS OUTLINED IN THE ATTACHED DOCUMENTS.**

- **Email:** communitydevelopment@keenenh.gov, with "Planning Board Application" in the subject line
- **Mail / Hand Deliver:** Community Development (4th Floor), Keene City Hall, 3 Washington St, Keene, NH 03431

The submittal requirements for Planning Board applications are outlined further in **Article 20** and **Article 25.12** of the [Land Development Code \(LDC\)](#). You may request an exemption from providing any of the items below, except the application fee, notice list, narrative, and mailing labels. The Community Development Director may grant an exemption, if it is determined that the scope of the project does not warrant the submittal.

*Note: Additional information may be requested by the respective decision-making authority during the review process.*

### GENERAL SUBMITTAL REQUIREMENTS

**CERTIFIED NOTICE LIST** (See Attachment A for more information.)

**2 SETS OF MAILING LABELS** (See Attachment A for more information.)

**PROJECT NARRATIVE** (See Section 1 of Attachment B for more information.)

**FEES:** Fill in the information below to calculate the total fee.

- \$250 base fee
  - \$0.05 per-sf of new construction x 0 sf of new construction
  - \$62 legal ad fee
  - 4.98 current USPS certified mailing rate x 14 abutters
- = 381.72 (TOTAL FEE)

**NOTE:** Please call the Community Development Department for the current certified mailing rate. Checks should be made payable to the *City of Keene*. Credit card payments are accepted in-person or by calling 603-352-5440.

**WAIVERS** (See Section 2 of Attachment B for additional information.)

- WAIVER(S) REQUESTED**
- NO WAIVER(S) REQUESTED**

PLAN SETS (See Attachment C for additional information.)	SUBMITTED	EXEMPTION REQUESTED
LOCATION MAP OF PROPOSED IMPROVEMENTS	Y	
EXISTING CONDITIONS PLAN	Y	
PROPOSED CONDITIONS PLAN	Y	
GRADING PLAN		Y
LANDSCAPING PLAN		Y
LIGHTING PLAN	Y	
ELEVATIONS		Y
TECHNICAL REPORTS (See Attachment C for additional information.)	SUBMITTED	EXEMPTION REQUESTED
DRAINAGE REPORT		Y
TRAFFIC ANALYSIS		Y
SOIL ANALYSIS		Y
HISTORIC EVALUATION		Y
SCREENING ANALYSIS		Y
ARCHITECTURAL & VISUAL APPEARANCE ANALYSIS		Y
OTHER REPORTS / ANALYSES		Y

**HUNDRED NIGHTS PERIMETER LIGHTING SITE PLAN APPLICATION**  
**122 Water Street (TMP: 585-027-000)**

**PROJECT DESCRIPTION**

---

The Applicant, Hundred Nights Foundation, Inc., proposes to install perimeter lighting on its property located at 122 Water Street (TMP: 585-027-000). The proposed lighting is requested by the abutting property owner to the east, the Railroad Street Condominium Association, as well as the Eastside Neighborhood Group, to enhance security and safety of pedestrians in the surrounding areas and to deter undesirable activity from occurring in currently unlit areas adjacent to Hundred Nights' homeless shelter. The proposed lights are fully-shielded, LED fixtures that will be mounted at a height of 10-feet above finished grade. The Applicant proposes to install 8 lights on the exterior of the perimeter fence on the north/east side of the property, as well as 2 lights on the exterior of the existing building. The building mounted lights will be installed near the southwest corner of the building.

Apart from the proposed lighting, no other changes are proposed to the site. As such the only applicable Development Standard is Lighting.

As the proposal is to provide offsite security lighting, a waiver is required from Section 20.7.3.C of the Planning Board's Development Standards, which prohibits light trespass of greater than 0.1 footcandle. Section 20.7.3.C states that: *"The maximum light level of any light fixture cannot exceed 0.1-footcandle measured at the property line and cannot exceed 1-footcandle measured at the right-of-way line of a street."* The maximum amount of light trespass proposed is approximately 7.7-footcandles, in the area closest to the existing fence line. Attached is a request for a waiver from Section 20.7.3.C.

Hundred Nights' homeless shelter is a 24-hour business and the purpose for the proposed lighting is security/safety of the surrounding area. The request is to maintain the proposed lighting levels from sundown to sunrise. As such, a waiver is requested from Section 20.7.3.F.1.c of the Planning Board's Development Standards, which requires that lighting levels for 24-hour businesses be reduced by a minimum of 50% between the hours of 10:00 pm and 6:00 am. Attached is a request for a waiver from Section 20.7.3.F.1.c.

**HUNDRED NIGHTS PERIMETER LIGHTING SITE PLAN APPLICATION**  
**122 Water Street (TMP: 585-027-000)**

**WAIVER REQUESTS**

---

**I. Waiver Request – Section 20.7.3.C**

The Applicant, Hundred Nights Foundation, Inc., respectfully requests a waiver from Section 20.7.3.C of the Planning Board Development Standards. Section 20.7.3.C, which relates to Light Trespass, states that:

*“The maximum light level of any light fixture cannot exceed 0.1-footcandle measured at the property line and cannot exceed 1-footcandle measured at the right-of-way line of a street.”*

An explanation for how the proposal meets each of the Planning Board’s Waiver Criteria is below.

1. *Strict conformity would pose an unnecessary hardship to the applicant and the waiver would not be contrary to the spirit and intent of the regulations.*

Strict conformity with the requirement of Section 20.7.3.C would make it impossible for the Applicant to meet the desires of the surrounding neighborhood and abutting property owner (the Railroad Street Condominium Association) for enhanced site safety and security. Currently, there is no lighting in the areas adjacent to the exterior of the site’s perimeter fence, and there is only egress lighting on the west- and south-facing building elevations. As the existing building and perimeter fence are located close to the property boundaries, it would not be possible to provide lighting around the site’s perimeter without having light trespass on the adjacent properties owned by the Railroad Street Condominium Association to the east (TMP: 574-041-000), the area of Community Way owned by the City of Keene to the west (TMP: 585-026-000), or the City’s Water Street right-of-way.

Granting the waiver would carry out the spirit and intent of the regulations as it would promote pedestrian safety and safer site design. In addition, it would satisfy the interests of the surrounding neighborhood, from where this request for improved lighting came.

2. *Specific circumstances relative to the site plan, or conditions of the land in such site plan, indicate that the waiver will properly carry out the spirit and intent of the regulations.*

As noted in #1 above, there is currently no lighting around the exterior of the site (on the street-facing side of the fence and building), and the placement of the existing perimeter fence and building make it impossible to adequately illuminate the site’s exterior without light trespassing onto surrounding properties or the City’s right of way. The waiver, which is to ensure site and pedestrian safety, is aligned with the purposes of the Planning Board’s Development Standards in Section 20.1.2 of the Keene Land Development Code.

3. *In granting a waiver, the Planning Board may require any mitigation that is reasonable and necessary to ensure that the spirit and intent of the standard being waived will be preserved, and to ensure that no increase in adverse impacts associated with granting the waiver will occur.*

The Applicant understands that the Planning Board may require mitigation as part of this waiver request.

## **II. Waiver Request – Section 20.7.3.F.1.c.**

The Applicant, Hundred Nights Foundation, Inc., respectfully requests a waiver from Section 20.7.3.F.1.c of the Planning Board Development Standards. Section 20.7.3.F.1.c, which relates to Hours of Operation, states that:

*“For 24-hour businesses, lighting levels shall be reduced by a minimum of 50% between the hours of 10:00 pm and 6:00 am.”*

An explanation for how the proposal meets each of the Planning Board’s Waiver Criteria is below.

1. *Strict conformity would pose an unnecessary hardship to the applicant and the waiver would not be contrary to the spirit and intent of the regulations.*

The proposed lighting is to provide sufficient night time illumination in the areas surrounding the perimeter of Hundred Nights’ homeless shelter. This lighting is intended to meet the request of the Eastside Neighborhood Group and the abutting property owner to the east (the Railroad Street Condominium Association) for improved security lighting in the areas adjacent to the site. If lighting levels are reduced to 50% between 10:00 pm and 6:00 am, which is the timeframe of greatest safety concern, it will not be possible for the Applicant to meet the request for enhanced safety/security lighting.

The waiver would not be contrary to spirit and intent of the regulations as it would promote pedestrian safety and safer site design.

2. *Specific circumstances relative to the site plan, or conditions of the land in such site plan, indicate that the waiver will properly carry out the spirit and intent of the regulations.*

The Eastside Neighborhood Group has expressed concern for safety around the site in the evening, including the hours of 10:00 pm and 6:00 am. While the existing use of the site is a homeless shelter, which is in operation 24-hours a day, it receives guests only between the hours of 2:00 pm and 9:30 pm. The proposed lights and light levels are intended to illuminate the perimeter of the site to discourage undesirable activity both during and after guests are admitted to the shelter. This proposal is aligned with the intent of the regulations to promote safer site design and pedestrian safety.

3. *In granting a waiver, the Planning Board may require any mitigation that is reasonable and necessary to ensure that the spirit and intent of the standard being waived will be*

*preserved, and to ensure that no increase in adverse impacts associated with granting the waiver will occur.*

The Applicant understands that the Planning Board may require mitigation as part of this waiver request.





Luminaire Schedule										
Symbol	Qty	Label	Arrangement	Description	Tag	LLP	Luminaire Lumens	Luminaire Watts	Total Lumens	Total Watts
□	3	P5-EX	Single	EXISTING POLE/FIXTURE: GPC-SA1A-730-U-5MQ-QM-BK	POLE MTD 12' AFG	0.900	4762	34	14286	102
□	2	P4-EX	Single	EXISTING POLE/FIXTURE: GPC-SA1A-730-U-SL4-QM-BK-HSS	POLE MTD 12' AFG	0.900	3680	34	7360	68
□	5	W-EX	Single	EXISTING WALL MTD UNIT, AKCS2A-W-BK-CBP	WALL MTD 10' AFG	0.900	2164	20.7	10820	103.5
□	10	W1	Single	COOPER: AKCS2A-W-CXX-OPTIONSXX	MOUNTED AT FENCE, 10' AFG // WALL MTD ON BLDG, 10' AFG	0.900	2164	20.7	21640	207

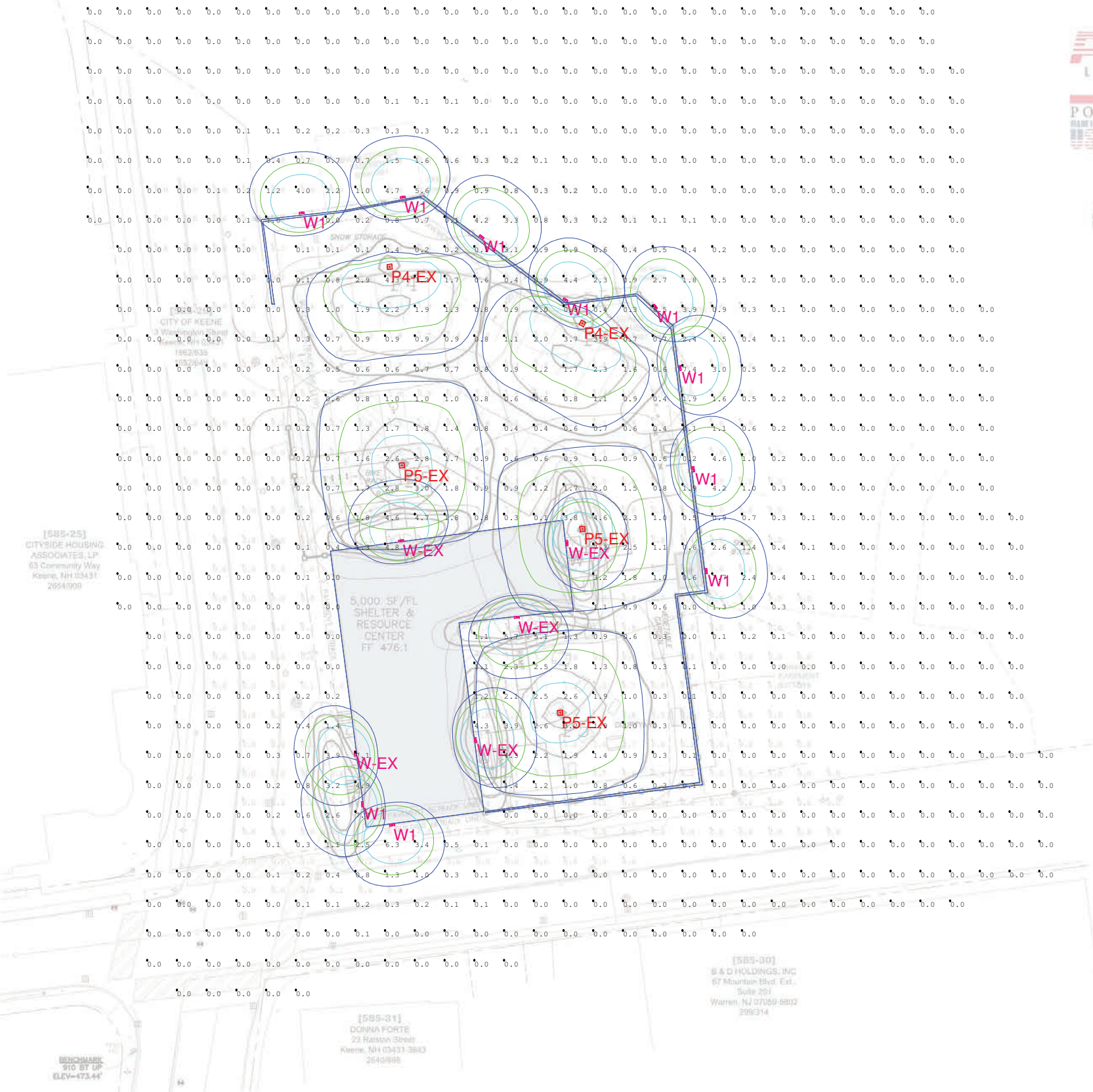

Comments	
Date	
#	
Revisions	

Drawn By: Michael O'Brien  
 Checked By:  
 Date: 1/18/2024  
 Contact: mobrien@charroninc.com  
 Scale: NTS

**Hundred Nights Security Lighting**  
 Community Way and Water Street  
 Keene, NH

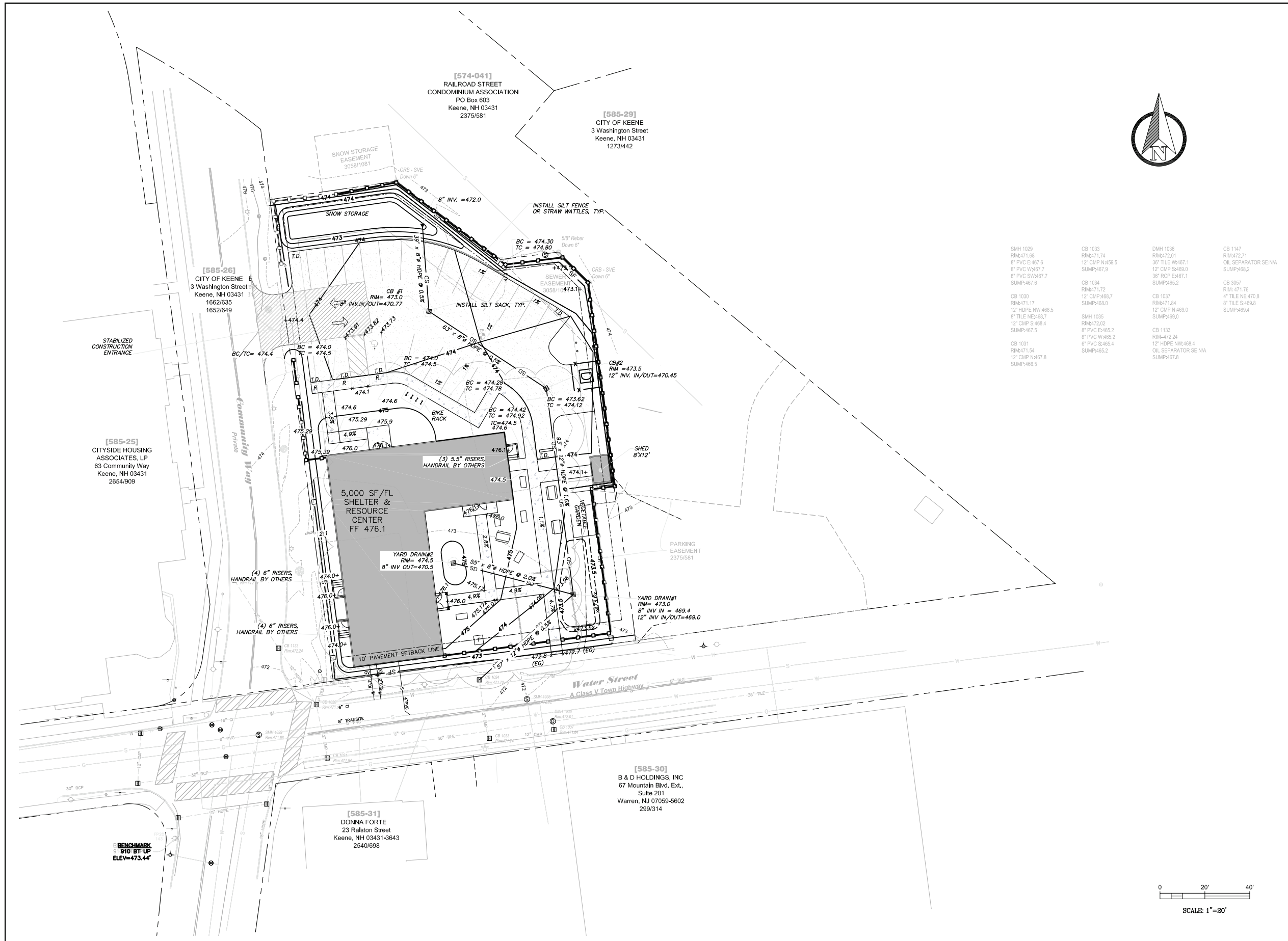

REVISIONS:  
8/3/21 PB COMMENTS  
9/2/21 REMOVED SPEED  
TABLE CROSSWALK  
4/6/22 REVISED GRADING  
6/24/22 SPOT GRADES  
9/2/22 SPOT GRADES  
9/14/22 SPOT GRADES

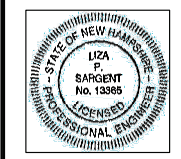

*Liza Sargent* 9/14/22  
LIZA P. SARGENT DATE  
R.C.E. NUMBER: 13365

OWNER/DEVELOPER:  
**GREEN DIAMOND GROUP LLC**  
143 CENTRE STREET  
EAST SULLIVAN, NH 03445

ENGINEER:  
**SVE**  
SVE Associates  
P.O. Box 1818  
439 West River Road  
Brattleboro, VT 05302  
T 802.257.0561  
F 802.257.0721  
www.sveassoc.com

PLANNER:  
**Brickstone Land Use Consultants LLC**  
Site Planning, Permitting and Development Consulting  
185 Winchester Street, Keene, NH 03431  
Phone: (603) 357-0116

PROPOSED SITE  
**HUNDRED NIGHTS SHELTER**  
122 & 124 WATER STREET  
KEENE, NH 03431

**GRADING & DRAINAGE PLAN**

SCALE: 1"=20'

DATE: JULY 16, 2021

SHEET C-2

Project		Catalog #		Type	
Prepared by		Notes		Date	



# Lumark

## Axcent

### Wall Mount Luminaire

#### Product Features



#### Product Certifications



#### Interactive Menu

- Ordering Information [page 2](#)
- Mounting Details [page 3](#)
- Product Specifications [page 4](#)
- Energy and Performance Data [page 4](#)
- Control Options [page 6](#)

#### Quick Facts

- Available in 14W - 123W (1,800 - 17,000 lumens) models
- Full cutoff and refractive lens models available
- Energy and maintenance savings up to 95% compared to HID
- Energy efficient illumination results in up to 144 LPW
- Replaces 70W up to 450W HID equivalents

#### Connected Systems

- WaveLinX Lite
- Enlighted

#### Dimensional Details

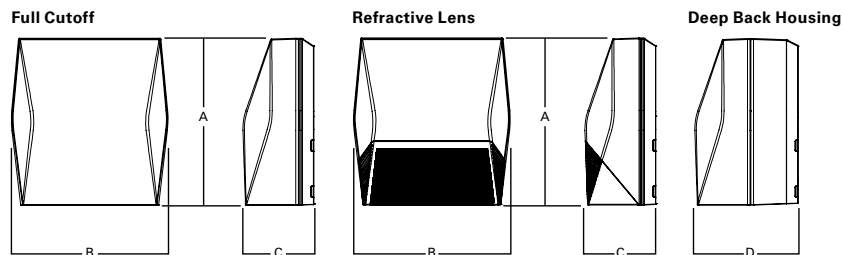

#### Dimensional Data

	AXCS Small	AXCL Large
A	8" [202mm]	11-1/2" [292mm]
B	7-1/2" [190mm]	10-3/4" [273mm]
C	3-5/8" [94mm]	4-7/8" [124mm]
D	6-1/8" [155mm]	7-1/8" [181mm]



February 16, 2024

**TO:** Planning Board  
**FROM:** Jesse Rounds, Community Development Director  
**RE:** 2025-2031 Capital Improvement Program

Every two years the City prepares a Capital Improvement Program (CIP) to plan for the coordinated implementation of capital projects in facilities, infrastructure, and equipment for the coming 7 years. The CIP provides a framework for the City to consider and prioritize projects in light of the needs and desires of the community, couched in the Comprehensive Master Plan.

Karen Gray, the City's Senior Accountant, will provide an overview of the Fiscal Year 2025-2031 CIP at the Planning Board meeting. The Planning Board is tasked with reviewing the proposed CIP and providing a recommendation to the City Council on whether or not to adopt the 7 year plan.

To aid you in making that determination, The City provides a one-day review of the Plan held on January 20. The plan was also presented project-by-project through presentations before the Finance, Organization, and Personnel Committee on January 25<sup>th</sup> and February 8<sup>th</sup>. If you were unable to attend the January presentation, copies of the proposed plan were provided at the January Planning Board meeting.

To review a digital version of the plan:

<https://keenenh.gov/sites/default/files/Finance/2025%20CIP%20with%20letter.pdf>

To review previous CIPs: <https://keenenh.gov/finance-purchasing/financial-documents>



February 16, 2024

**TO:** City of Keene Planning Board  
**FROM:** Harrold Farrington, Planning Board Chair  
**THROUGH:** Jesse Rounds, Community Development Director  
**SUBJECT:** Master Plan Steering Committee Nomination

**Recommendation:**

To appoint Pamela Russell-Slack to serve as a regular member on the Master Plan Steering Committee to fill the spot vacated by Armando Rangel (Slot #2).

**Background:**

On January 21, 2024, Armando Rangel submitted his resignation from the Master Plan Steering Committee. The email correspondence from Armando is included as an attachment to this memo.

In order to fill the spot vacated by Armando Rangel, I hereby nominate Pamela Russell-Slack to serve on the Planning Board Master Plan Steering Committee. Pamela Russell-Slack was born and raised in Keene and has been an active member of the Keene community for many years. She has served in several different public service roles including as a Planning Board member, City Councilor, and State Legislator (among others). She currently works for U.S. Senator Jeanne Shaheen’s Office as the Senior Special Assistant for Constituent Services.

## Mari Brunner

---

**From:** Mari Brunner  
**Sent:** Tuesday, January 30, 2024 8:21 AM  
**To:** Jesse Rounds  
**Subject:** FW: Master Plan Steering Committee

---

**From:** Armando Rangel  
**Sent:** Sunday, January 21, 2024 5:00 PM  
**To:** Mari Brunner  
**Cc:** Jesse Rounds  
**Subject:** Re: Master Plan Steering Committee

Hi, Mari,

It is my understanding from Harold that there was a high number of Planning Board committee members on the Master Plan Steering Committee, and the City Attorney advised that some Planning Board members should be asked to leave the Master Plan Steering Committee. Harold asked if I would be willing to step off of the Master Plan Steering Committee and I said I would. Although I would have liked to be part of the work that will be carried out by the Master Plan Steering Committee, I am not sure I have the bandwidth to participate in another committee, so this change turns out to be mutually beneficial.

I look forward to being involved in the Master Plan process through other avenues/engagement opportunities.

Thanks,  
Armando